

**Strategies to prevent falls in the elderly: Effect of a 10-week Taiji training program on proprioception, functional strength and mobility, and postural adaptation**

A thesis presented to the  
School of Kinesiology  
Lakehead University

In partial fulfillment  
of the requirement for the degree  
of Masters in Kinesiology with  
specialization in Gerontology

by  
Anshul Jain

## Table of Contents

Abstract .....	i
Acknowledgement .....	iii
Introduction.....	1
Review Of Literature .....	3
Risk Factors Associated With Falls In The Elderly .....	4
Muscle Strength In Older Adults.....	4
Interventions to improve muscle strength .....	6
Assessment of functional strength of lower extremity in older adults .....	7
Balance And Mobility In The Elderly.....	8
Intervention to improve balance and mobility.....	9
Assessment of functional balance and mobility .....	11
Proprioception In Older Adults .....	13
Interventions to improve proprioception in the elderly .....	15
Assessment of proprioception .....	16
Research Problem .....	19
Hypotheses .....	20
Objective Of The Research .....	21
Significance Of This Study .....	22
Method.....	22
Pilot Study.....	22
Inclusion criteria for participants for pilot study.....	22
Exclusion criteria.....	22
Instruments for pilot study.....	23
Procedure for proprioception assessment.....	24
Analysis .....	25
Result of pilot study.....	25
Main Study.....	26
Research design .....	26
Participant recruitment .....	26

Procedure for main study.....	27
Instruments .....	27
Procedure for functional mobility assessment.....	28
Procedure for proprioception assessment.....	29
Procedure for functional strength assessment .....	30
Procedure for group allocation .....	30
Intervention .....	31
Data Analysis .....	31
Limitations.....	33
Result .....	33
Participant Characteristics.....	33
Log Book Records For Taiji And Control Group .....	35
Performance On Measures Of Ankle Proprioception.....	36
Post proprioception Trial Interview .....	37
Performance On Measures Of Functional Strength .....	38
Performance On Measures Of Functional Mobility.....	39
Performance On Measures Of Postural Control And Postural Adaptation .....	42
Correlation Of Scores In Taiji Group.....	45
Subjective Performance On Taiji Quan Social Validation Survey .....	46
Discussion .....	48
The Effect Of Taiji On Ankle Proprioception.....	48
The Effect Of Taiji On Functional Strength Of Lower Extremities.....	51
The Effect Of Taiji On Functional Mobility .....	52
The Effect Of Taiji On Postural Control And Postural Adaptation .....	54
Summary .....	55
Limitations And Recommendations.....	56
References.....	57
Appendix.....	71
Appendix A Pilot Study Consent Form.....	71
Appendix B Proprioception Testing Device .....	73
Appendix C Research Information Poster.....	74

Appendix D Main Study Consent Form.....	75
Appendix E Cover Letter .....	77
Appendix F Participant Demographic And Fall History Information.....	80
Appendix G PAR-Q + Questionnaire.....	81
Appendix H Social Validation Questionnaire .....	85
Appendix I Adapted Timed Get Up And Go Test.....	87
Appendix J Proprioception Questionnaire .....	88
Appendix K 30-Second Chair Stand Test .....	89
Appendix L Study Design .....	90
Appendix M Sample Weekly Activity Logbook For Taiji Group .....	91
Appendix N Sample Weekly Physical Activity Logbook For Control Group.....	92
Appendix O Independent Sample T-Test Pre Intervention Both Group .....	93
Appendix P ICC Coefficient Of The Proprioception Measures From Pre And Post Test For Taiji And Control Group.....	94
Appendix Q ICC Coefficient Of The ATGUG Measures From Pre And Post Test For Taiji And Control Group.....	95
Appendix R ICC Coefficient Of The Quiet Standing Eyes Open Measures From Pre And Post Test For Taiji And Control Group .....	96
Appendix S ICC Coefficient Of The Quiet Standing Eyes Close Measures From Pre And Post Test For Taiji And Control Group .....	97
Appendix T ICC Coefficient Of Balance Space Measures From Pre And Post Test For Taiji And Control Group.....	98

## **List of Tables**

1	Internal reliability of proprioception test while forward and backward practice trials .....	25
2	Comparison of means and standard deviations of participant demographics pre intervention .....	35
3	Comparison of means and standard deviations of the proprioception measures from pre and post test for Taiji and control group .....	36
4	Comparison of means and standard deviations of the 30-Second Chair Stand Test measures from pre and post test for Taiji and control group .....	38
5	Comparison of means and standard deviations of the functional mobility measures between pre and post test for Taiji and control group .....	40
6	Comparison of the means and standard deviations of the postural control and postural adaptation measures between pre and post test for Taiji and control group .....	43

## List of Figures

- 1 The interaction plot of Taiji and control group from pre intervention (time 1) to post intervention (time2). Assessment of measures of proprioception ..... 37

## Abstract

The impact of elderly falls on the Canadian health care system is widespread. Balance and motor coordination are commonly affected during the aging process due to declining proprioception (Ribeiro & Oliveira, 2007). In addition, there is slower walking speed and shorter stride length among fallers (Wolfson, Judge, Whipple, & King, 1995). Robinovitch et al. (2013) reported that 41% of falls in long term care homes were attributed to incorrect weight shifting. Considering the strong relationship between falls in the elderly and declining proprioception (Mion et al. 1989), the purpose of this study was to examine the effects of a 10-week Taiji training program on ankle proprioception, functional lower extremity strength and mobility and postural adaptation of older adults at risk of falls.

A sample of 32 older adults ( $M = 66.5$ ,  $SD = 4.94$ ) participated in this study. Sixteen participants were conveniently assigned to the Taiji group; practiced Taiji Quan 6-form twice weekly for 60 minutes for 10-weeks, and completed their weekly Taiji logbook. The remaining 16 participants in the control group; continued their regular activities except Taiji and completed their weekly logbook. All the participants completed pre and post assessments of postural control on an AMTI force platform, functional mobility on the Adapted Timed Up and Go Test (ATGUG), ankle joint proprioception i.e., perception of joint movement sensation, on a tilting platform, and functional strength of lower extremities on the Chair Stand test. A two by two mixed factorial ANOVA indicated significant changes with large effect size for proprioception (backward angle), lower extremity strength (repetitions), functional mobility (ATGUG 5 and ATGUG 4) and medium effect size for functional mobility (ATGUG 2). Changes in

the proprioception variable suggest that Taiji may be a valuable alternative to traditional exercise programs. As Taiji exercises are beneficial in enhancing ankle joint backward movement perception and it also increases the efficacy of body movement by promoting protective effects against declining physical functions. Future studies should implement randomized controlled design and a larger sample size.



## **Acknowledgements**

First and foremost, I am eternally thankful to the almighty for being so magnificent. I owe you a huge debt of gratitude for providing me with such a wonderful life. Second, I would like to extend massive thanks to my caring and loving supervisor Dr. Jane Taylor. It has been hard work, ridiculously difficult at times, but extremely rewarding, and I am surprised and amazed to have made it to this point. It is all possible because of your generous advice, support, calmness, and encouragement every time. I never felt like I was away from my parents. You will remain in my morning prayers forever.

Third, I would like to thank my committee members, Dr. Paolo Sanzo and Dr. Carlos Zerpa, for providing their valuable feedback, guidance and supporting me all the way to the end. I am thankful to Dr. Carlos Zerpa and Dr. Eryk Przysucha for their assistance and interpretation with the statistics in this study. It helped me a lot to evaluate the data and improved my skills in statistics.

Fourth, I would like to thank our Taiji Instructors Oliver Reimer and Master Peng You, for their commitment and dedication to this study and Master Peng for the Taiji DVDs. I would like to thank Oliver Reimer and Nancy Angus for helping me in recruiting the participants. Without your help, I might not be able to get the participants for this study. I would also like to thank all our participants who spent their summer with us practicing Taiji.

Last but not least, I would like to thank my parents for encouraging me, teaching optimism and constant support. I am also thankful to my love, Dimple.

## Introduction

A fall can be defined as an unintentional, unplanned descent to the floor, ground or lower level (Agostini, Baker, & Bogardus, 2001; Nevitt, Cummings, & Hudes, 1991; Tinetti, Speechley, & Ginter, 1988). Falls in the elderly are a common and costly problem. Falls are prevalent across the globe and have dreadful consequences (Al-Aama, 2011; Kannus, Parkkari, & Palvanen, 2005; Salva, Bolibar, Pera, & Arias, 2004; Spaniolas et al., 2010; Stel, Smit, Pluijm, & Lips, 2004; Stevans, Corso, Finkelstein, & Miller 2006; Woolf & Akesson, 2003). Falls in the elderly have multifactorial etiologies including reduced ankle and knee muscle strength, dizziness, blackouts, tripping, and loss of proprioception (Blake et al., 1988). A fall usually results from relations between long-term (restricted mobility, cognitive impairment, impaired vision, gait, and balance) or short-term factors (orthostatic hypotension, acute exacerbations of chronic illness) and short-term precipitating factors (polypharmacy, trip, acute musculoskeletal injury) in a person's surroundings (Al-Aama, 2011).

The impact of elderly falls on the Canadian health care system is widespread. For example, in 2009-2010 over 53,500 Canadians aged 65 years and older were hospitalized due to falls and related injuries. The direct health care costs for fall-related injuries were more than \$2 billion (Scott, Wager, & Elliot, 2010). In Northwestern Ontario, from 2008-2010, the annual number of emergency visits due to falls among older persons aged 65 and over was approximately 2,300, with head injuries due to falls diagnosed as the leading cause of mortality in the elderly fallers (Hohenadel, 2012). It is anticipated that the number of elderly falls will increase in Northwestern Ontario, as the total population aged 65 and over will increase from 15% of the population to 27% in the next 20 years;

and the number of seniors will increase by 78%, from 36,000 to over 63,000.

The effect of lower extremity muscle weakness is a clinically important risk factor for falls. In a systematic review and meta-analysis Moreland, Richardson, Goldsmith, and Clase (2004), suggested that weakness in lower limb muscles is a significant risk factor for falls among community dwelling older adults. Ankle plantarflexors and dorsiflexors are constantly working to maintain erect static and dynamic postural control. Plantarflexors demonstrate increased activation during forward postural sway to prevent loss of balance. Similarly, ankle dorsiflexors provide support during backward sway. Weakness in these muscle groups can severely impair the stability and mobility of the individual and predispose one to fall (Winter, 1995).

The spectrum of disorders arising from falls in the elderly ranges from minor bruises, to fractures and/or head injuries, consequently resulting in restricted activities and immobility. Sometimes falls also result in immediate hospitalization. In either situation, a loss of independence is observed, thereby affecting the quality of life (Herman, Gallagher, & Scott, 2006; PHAC, 2005; Scott, 2005; Scuffham, Chaplin, & Legood 2003; Talbot, Musiol, Witham, & Metter, 2005).

Multidimensional strategies such as physical exercises, psychological guidance, dietary supplements, pharmacological agents, modified orthotics, walking aids, and environmental modifications are widely accepted in fall prevention and rehabilitation programs. Physical activities emphasizing muscle strength, balance, flexibility, and endurance training are most effective in preventing elderly falls (Karlsson, Magnusson, Von Schewelov, & Rosengren, 2013). In recent years, researchers have been attracted to targeted intervention for identified contributing factors. Most review studies have shown

promising results of combined physical activities on elderly fall prevention (Costello & Edelstein, 2008). Gillespie et al. (2012) reported a significant reduction in falls risks and rate of falls in the elderly. Additionally, they suggested Taiji (Taichichuan) as a single category program, capable of inducing effective results compared to balance retraining or muscle strengthening exercise alone.

Taiji is characterized by its meditative and relaxing effect induced by slow, rhythmic, and graceful movements with coordination of the upper and lower extremities and breathing pattern (Liu et al., 2012). It is beneficial in improving strength, endurance, flexibility, and balance (Hong et al., 2000; Lan, Lai, Chen, & Wong, 2000; Lu, Hui-Chan, & Tsang, 2012; Wolf et al., 1996). Some of the fall prevention studies have demonstrated the efficacy of Taiji on older adults in reducing the fall rate, risk of falls, and fear of falling (Lin, Hwang, Wang, Chang, & Wolf, 2006; Wolf et al., 1996; Wu, 2002). Despite all of these documented effects of Taiji practice, its clinical implication in fall prevention programs is not demonstrated. Although a considerable amount of studies have been conducted to determine the effects of various exercises on fall prevention, to date, little is known of the neural mechanism of Taiji, though it is commonly used as a recreational activity by older adults.

### **Review of Literature**

Approximately, one third of the population aged 65 and over experience a minimum of one fall annually (O'Loughlin, Robitaille, Biovin, & Suissa, 1993). The consequences of falls are more severe in the elderly and among one of the most prominent causes of morbidity and mortality. Even a single fall episode is effective enough to impair functional mobility and psychological well-being of the individual.

Falls are commonly associated with restricted activities and prolonged immobility (Tinetti et al., 1988).

### **Risk Factors Associated With Falls in the Elderly**

Abundant research is being conducted to quantify the risk factors for falls in the elderly. Many authors classify the risk factors as either internal or external (Cavanillas, Ruiz, Moleon, Alonso, & Vargas, 2000; Todd & Skelton, 2004). Internal factors for falls most commonly include aging (Blake et al., 1988; O’ Loughlin, Robitaille, Biovin, & Sulssa, 1993); impaired balance and mobility (Djaldetti, Lorberboym, & Melamed, 2006; Horlings, Engelen, Allum, & Bloem, 2008); musculoskeletal weakness (Evan, 1995; Liperoti, 2012); poor vision (Ivers, Cumming, Mitchell, & Attebo, 1998); impaired proprioception (Ribeiro & Oliveira, 2007; Sturniek, George, & Lord, 2008; Tunnainen, Rasku, Jantti, & Pykko, 2013); a previous history of falls (Arfken, Lach, Birge, & Miller, 1994; Scheffer, Schuurmans, Dijk, Hooft, & Rooij, 2008); and poly pharmacy containing sedatives and psychoactive drugs (Hammond & Wilson, 2013; Weiner, Hanlon, & Studenski, 1998). External factors include poor lighting, unsafe stairways, and walkways (Fuller, 2000); improper foot wear, walking aids and home hazards such as torn carpets and foot catching on the furniture, ground, and/or equipment (Boelens, Hekman, & Verkerke, 2013; Robinovitch et al., 2013; Vieira, Heritage, & Costa, 2011).

### **Muscle Strength in Older Adults**

Age related changes in the neuromuscular system are evident after the age of 70 (Doherty, Vandervoort, & Brown, 1993). Christou and Carlton reported a 40% decline in maximal isometric strength in older adults, when compared to younger adults (2001). This decrease in strength can be attributed to age associated reduction in the mass and

cross-sectional area (CSA) of muscles (Verdijk et al., 2010); however, declining muscle mass and CSA in the elderly can also be linked to a reduction in motor units. Prolonged immobility and restricted activities also contribute to muscle atrophy. Tomlinson and Irving (1977) studied the number of limb motor neurons in the human lumbosacral cord throughout life. Studies were performed on 47 participants through post mortem examinations. They concluded that there was a 50% reduction in motor neuron counts in persons 60 years and older. This study supports the linkage between declining muscle mass and a reduced number of motor units with age; Evans (1995) termed it *sarcopenia*. In line with these findings, Visser et al. (2002) studied the effect of muscle mass and body composition on lower extremity performance in adults aged 70-79 years. They found significantly poor lower extremity performance in individuals with a smaller CSA of the mid thigh. In addition, Liperoti et al. (2012), reported sarcopenic individuals are three times more likely to fall compared to non sarcopenic individuals.

Wolfson, Judge, Whipple, and King (1995), studied the role of strength, balance, and gait in falls incidents. They recruited 34 nursing home residents. Seventeen participants were fallers. The authors measured the peak torque for knee and ankle muscles of the dominant leg using an isokinetic dynamometer in fallers and non-fallers and reported significant decline in the peak torque production of knee flexion and extension in fallers. Ankle strength was also comparatively weaker in the control group, especially in the dorsiflexors. Results of the postural stress test indicated significant differences in balance parameters between fallers and non-fallers. In addition there was slower walking speed and shorter stride length among fallers. It is clear from this study that strength, gait, and balance are important determinants in elderly falls and should be

considered priorities when devising falls prevention exercise programs.

**Interventions to improve muscle strength.** Exercise interventions such as calisthenics, balance training, and muscle strength training are effective in improving age associated loss of strength. Iwamoto et al. (2009) examined the effect of a five month calisthenics, body balance training, muscle power training, and walking ability training program on 68 older adults. The participants were randomly assigned to either an exercise group (n=34) or a control group (n=34). The results showed significantly improved flexibility, balance, muscle power, and walking ability in the exercise group compared to the control group. Fall incidence was also significantly reduced in the exercise group. Lord et al., (2005) reported that individualized training programs are effective in falls prevention in the elderly. However, participants demonstrate poor adherence (Dishman, Sallis, & Orenstein, 1985). Exercise training improves the performance but has various limitations. For example, some exercises require a specialized set up like a gym or rehabilitation unit; others have a low adherence rate, require various safety precautions, and require trained personnel to administer the program. All of these limitations have a profound effect on the wide spread application of exercise programs, hence, a simple and easily adaptable mode of exercise should be implemented for those who have limited mobility or access to advanced rehabilitation settings.

Taiji is a form of mind body exercise developed in ancient China (Chang, Nien, Tsai, & Etnier, 2010). Taiji exercise has beneficial effects on balance (Hong, Li, & Robinson, 2000; Wolf et al., 1996); flexibility (Hong et al., 2000); strength (Lu, Hui-Chan, & Tsang, 2012) and endurance (Lan, Lai, Chen, & Wong, 2000). Sattin, Easley,

Wolf, Chen, and Kutner (2005) examined Taiji and its effect on fear of falling and reported that 48-weeks of Taiji significantly reduced the fear of falling in transitionally frail older adults. Similar findings were reported by Li et al. (2005). The authors conducted a randomized controlled trial on a sample of 256 community dwelling older adults. Six months of Taiji practice significantly decreased the risk of falling by 55%. It also significantly reduced the number of falls at the end of the intervention in the Taiji group to 38 as compared to 73 falls in the stretching control group. Changes were evident after three months of training. Taiji is widely acceptable to seniors due to its slow and relaxing movement pattern. It may be practiced in a group which is helpful in promoting social interaction. After learning, it can also be practiced at home or recreational parks. Taiji moves are simple, coordinated, dance like movements which can be easily adopted after a couple of training sessions. Based on these qualities, Taiji can help in enhancing mobility and functional independence in older adults and reducing health related costs. It would be a logical addition to fall prevention programs to achieve beneficial outcomes.

**Assessment of functional strength of lower extremity in older adults.** Lower extremity muscle weakness is identified as an important fall risk factor (Ghelsen & Whaley, 1990; Whipple, Wolfson, & Amerman, 1987). Muscle strength evaluation is a simple process. It can be assessed using manual muscle testing, with specialized equipment such as a dynamometer, and/or with the use of various functional measurement tools. Feasibility and reproducibility are considered when choosing an appropriate test measure. The dynamometer is used for assessing strength in clinical settings but requires a trained professional and is also time consuming. A 30-second chair stand test is one of the most widely used measuring tools for assessing lower extremity



muscle strength in the field (Jones, Rikli, & Beam, 1999). It is easy to administer and can be performed in a short duration. This test assesses functional strength of the lower extremities, which is also more applicable or meaningful to older adults. The test has been reported as having high test-retest reliability (ICC 0.84 for men, and 0.92 for women) in a sample of 76 older adults. The authors also observed a moderately high correlation with a maximum weight adjusted leg press for both men and women ( $r=0.78$  and  $0.71$  respectively) (Jones et al., 1999). ICC values above 0.75 represent acceptable reliability (Fleiss, 1986).

### **Balance and Mobility in the Elderly**

Balance is defined as the ability to maintain the body's position over its base of support (BOS) (Berg, Wood-Dauphinee, Williams, & Guyton, 1989). Balance plays a major role in the performance of functional tasks (Silsupadol, Siu, Shumway-Cook, & Woollacott, 2006) and maintenance of erect postures (Winter, 1995). Balance in bipedal stance is a complex phenomenon, requiring constant input from the visual, vestibular, and somatosensory systems to exercise static and dynamic postural control (Konrad, Girardi, & Helfert, 1999). During walking, balance is necessary to keep the center of mass within a continually moving BOS (Lugade, Lin, & Chou, 2011). Due to age related decline in visual, vestibular, and proprioceptive inputs, it is often difficult to maintain balance (Baloh, Ying, & Jacobson, 2003; Sturnieks, George, & Lord, 2008).

Balance is shown to be a good predictor of falls in the elderly population. The role of postural control in elderly falls is being extensively examined. Lajoie and Gallagher (2004) determined the importance of balance in predicting falls within community dwelling elderly. They recruited 125 participants; 45 were classified as fallers.

Assessment of postural sway, Berg Balance Scale (BBS), Activities Specific Balance Confidence Scale (ABC), and reaction time were measured. The non-fallers showed significantly fast reaction time, improved scores on the BBS and ABC. Fallers oscillated at higher frequency compared to non-fallers on postural sway analysis.

**Intervention to improve balance and mobility.** Exercise training is highly effective in reducing falls and preventing fall related injuries. Province et al. (1995) reported a 17% reduction in falls risk in older adults participating in the exercise programs that included balance training. Madureira et al. (2007) studied the effect of 12-months of balance training for 66 women with osteoporosis. They reported significant improvement in functional and static balance and mobility and also reported a reduced number of falls after 12 months of balance training delivered once a week for an hour.

In the western world, Yoga is also a popular form of physical exercise. It is aimed at improving muscle strength, endurance, flexibility, and postural control (Tiedemann, O'Rourke, Sesto, & Sherrington, 2013). It is also beneficial in reducing the number of falls in the elderly (Kelley, 2013). Zettergren, Moriarty, and Zabel (2005) reported significant improvement in the Tinetti Balance Scale measures of nine community dwelling elderly adults, after a four week yoga training program. Schmid, Puymbroeck, and Koceja (2010) studied the effect of a 12-week yoga intervention for 14 elderly participants. The yoga sessions were 75-minutes long and given twice per week. The authors reported an 8% decrease in fear of falling, 30% increase in lower body flexibility, and 7% increase in upper body flexibility after a 12-week yoga intervention. Similar results were reported by Brown, Kaziol, and Lotz (2007) in their study on yoga-based exercise and its effect on risk of falls in seniors. Thirteen specially designed yoga poses

were implemented with 27 participants, 65 years and older, for three months. Participants were initially assessed, using the BBS, ABC, and One Leg Standing Test (OLST). An 18% dropout was reported during the study. After three months of yoga training the authors reported, 14 of the 22 participants had improved BBS scores relative to baseline; 13 participants demonstrated improved ABC scores, and 15 participants demonstrated improved OLST.

Exercise training requires special settings and equipment. Although exercises are effective, regular adherence and enjoyment are not high. Some alternate programs should be implemented to reduce the rate and risk of falls in older adults. Taiji is considered to be an effective exercise for improving balance and coordination. Allen and Taylor (2001) recruited 34 community-dwelling elderly female participants who practiced Taiji for 10-weeks. The authors reported significant improvement in balance control and stability in all the participants with greater improvement in 18 novice participants.

Taiji practitioners have shown significant improvement in knee extensor eccentric strength and smaller centre of pressure (COP) sway for both eyes open and eyes closed conditions compared to non Taiji group members (Wu, Zhao, Zhou, & Wei, 2002). The authors studied the effect of Taiji training on knee joint isokinetic strength and postural stability. The participants in the Taiji group (n=20) were veteran Taiji practitioners (greater than 3 years of practice). Force plate measures revealed significantly less COP excursion in antero-posterior (AP) and medio-lateral (ML) directions during static stance in Taiji practitioners compared to the non Taiji group. Also, there was significant correlation between isokinetic strength of the knee extensors

and COP excursion ( $r=-0.37$ ). The authors suggested this change is due to eccentric activation of knee extensors in a long term Taiji practice. In a similar study, Mak and Ng, (2003) assessed 19 Taiji practitioners and 19 healthy controls for functional reach, gait, and postural sway. The authors concluded that long term Taiji practitioners have better clinical test scores for functional reach, gait speed, stride length, and sway parameters during single limb stance. They also suggested that postural control is associated with the number of years of Taiji experience. This improved postural control in the ML direction is attributed to single limb standing practice in Taiji training.

In contrast to these studies, Wolf, Barnhart, Ellison, Coogler, and FICSIT (The Frailty and Injuries: Cooperative Studies of Intervention Techniques) Atlanta group, (1997) reported minor changes in stability among Taiji participants compared to the computerized balance training group. They studied the effect of 15 weeks of Taiji on 16 participants (12 successfully completed) and measured postural stability using a Chatter balance system under four conditions (quiet standing eyes open, eyes closed, toes up with eyes open, and toes up with eyes closed). They reported that balance training is more effective compared to Taiji training to improve postural stability in older adults. The authors, however, did report Taiji to be effective in reducing the fear of falling.

**Assessment of functional balance and mobility.** A wide variety of measurement tools are available to examine balance. Moreover, balance tests are based on the rating of the balance responses on a scale with specific guidelines. Performance Oriented Mobility Assessment (POMA), BBS, and Timed Up and Go Test (TUG) are some commonly used tests in clinical settings. The POMA and BBS are good tools to evaluate static and dynamic balance control, but require more than one health care professional to

administer, and take a lot of time to complete compared to the TUG. Although the POMA has two separate test components which measure gait and balance activities in the elderly, it requires a trained professional for assessment of the tasks (Van Swearingen & Brach, 2001). The time required to complete the POMA is about 15-20 minutes, and this is not acceptable to most elderly participants. The BBS is primarily intended to measure balance among the elderly but some of the tasks in the test are not feasible to administer in this population of elderly, for example, standing on one foot and standing unsupported with one foot in front of other. This test also requires a trained professional to judge the performance. The time needed to complete all 14 tasks of the BBS is around 15-20 minutes. Functional mobility and balance can be assessed using the TUG Test, as it is less time consuming and plausible. It is easy to execute, does not require a trained professional, and can be completed in 5-7 minutes.

Functional mobility is commonly assessed using the TUG Test. This test measures the time taken by the participant to get up from a chair, walk 3-metres, turn around, and return back to the seat. The TUG test highly correlates to functional mobility (ability to efficiently execute the ambulation during daily activities) in older adults (Podsiadlo & Richardson, 1991; Shumway-Cook, Brauer, & Woolacott, 2000). The TUG has high test-retest reliability (ICC= .97) in a study on 96 healthy older adults (Steffen et al., 2002). A strong negative correlation between TUG and an index of activities of daily living (ADL) has been reported, which relates the score of the TUG with level of independence in performing ADLs (Podsiadlo & Richardson, 1991). Wall, Bell, Campbell, and Davis, (2000) devised an Expanded Timed Get-Up and Go test (ETGUG) in which each segment of the test is timed separately and the distance to walk is increased

to 10 meters. It is more sensitive and clinically useful as it isolates the tasks and provides vital information related to specific functional deficits. Due to its extended walking distance, its applicability in older adults may be limited. The Adapted Timed Get-Up and Go Test (ATGUG) is similar to the ETGUG but the walking distance is kept to three meters. It has been successfully used in cancer patients (Yang, 2008), and multiple sclerosis patients (Kirstein & Taylor, 2006).

Postural control is commonly evaluated using posturographic assessment. It is based on recordings of COP excursion on a force platform. Increased postural sway reflects insufficient balance or poor postural control (Thapa, Brockman, Gideon, Fought, & Ray, 1996). Evaluation consists of static and dynamic postural assessment.

Assessment of postural control requires participants to stand as still as they can with eyes open and eyes closed on a force platform. Whereas, in postural adaptation the participant moves to his/her limits of stability by leaning forward, backward, and sideways on the platform. Outcome parameters are AP sway, ML sway, total area of sway, COP, and total sway path length.

### **Proprioception in Older Adults**

The term proprioception was coined by Sherrington (1906). It can be described as sensory information that contributes to the perception of joint and body movement as well as position of the body, or body segments, in space (Johnson & Soucacos, 2010). Joint position sense and sense of limb movement are vital for the execution of smooth and coordinated movements, balance control, maintenance of normal body posture, and motor learning (Tsang & Hui-Chan, 2003; Ghez & Sainburg, 1995).

Muscle spindles are special receptors in the muscle which sense any change in

length and tension changes of the skeletal muscle. Therefore, muscle spindles are the primary receptors for sensing proprioception, i.e., joint movement (kinesthesia) and joint position sense (Porske, 1997). Liu, Eriksson, Thornell, and Pedrosa-Domellof (2005) reported age-related changes in human muscle spindles which mainly involved decreased intrafusal fibres due to significant reduction in nuclear chain fibres. These changes can accelerate age related deterioration in sensory and motor innervations with significant impact on motor control in the elderly. Proprioception declines with age (Stelmach & Sirica, 1986). Mion et al. (1989) reported that impaired proprioception is the major predictor of falls in the elderly. Sachs (2008), in his review article emphasized the effect of sarcopenia on proprioceptive acuity in older adults. The author suggested decreasing level of hormones such as testosterone, growth hormone, and insulin-like growth factors along with reduced number of satellite cells in muscles are major factors responsible for sarcopenia in older adults. He also highlighted that the predominance of type-I slow twitch muscle fibres in elderly individuals inhibits their ability to make quick, and forceful movements which are vital for maintaining balance through rapid postural reflexes.

Balance and motor coordination are commonly affected during the aging process due to declining proprioception (Kaplan, Nixon, Reitz, Rindfleish, & Tucker, 1985; Petrella, Lattanzio, & Nelson, 1997; Ribeiro & Oliveira, 2007). Ghez, Gordon, and Ghilardi (1995) showed delayed movement onset and inaccurate trajectory formation in patients with proprioceptive loss. Lord, Rogers, Howland, and Fitzpatrick (1999) reported that impaired lower limb proprioception, quadriceps strength, and reaction time were the best predictors of increased maximal sway in the near-tandem stability test with eyes

open. Also reduced proprioception, quadriceps strength, and age, were found to be the best determinants of the necessity of taking a step in the near-tandem stability test with eyes closed. In line with these findings, Robinovitch et al. (2013), in their observational study using video capture of falls episodes in long term care homes, reported that 41% of falls were attributed to incorrect weight shifting.

**Interventions to improve proprioception in the elderly.** Can this process of degeneration be arrested? Gauchard, Jeandel, Tessier, and Perrin (1999), in their study concluded that proprioceptive exercises can impact balance control. These authors compared the effect of proprioceptive exercise (group 1), bioenergetic physical activities like jogging, swimming, and cycling (group 2), and regular walking (group 3) on healthy adults aged 60 and older. All three groups were assessed on dynamic posturography and lower limb muscular strength. The control group, with regular walking practice, exhibited poor balance performance and muscle strength; the proprioceptive training group demonstrated the best postural adaptation with normal muscle strength; and the bioenergetic physical activity group showed significantly improved muscle strength, but poor postural adaptation.

In Taiji, the emphasis is on conscious awareness of body position and movement (Jin, 1992; Lan, Lai, & Chen, 2002; Taylor-Piliae, Silva, & Sheremeta, 2010). Xu, Hong, and Chan (2004) studied the effect of Taiji on proprioception of the ankle and knee joint in older adults and reported improved proprioception in participants with a history of 1.5 hours of daily practice of Taiji over four years or more. Jacobson, Chen, Cashel, and Guerrero (1997) reported positive changes in lateral body stability, kinesthetic sense in the glenohumeral joint at 60°, and strength of the knee extensors after 12 weeks of Taiji



training three times a week. The authors also supported the Taiji method of training as a low stress method to enhance stability, kinesthetic sense, and strength of the knee extensors. Xian, Qing, and Hong (2008) studied the effect of a 16-week Taiji intervention on postural stability and proprioception of the knee and ankle in older people. They found a significant difference in proprioceptive function of the knee and ankle, and postural stability after a 16-week Taiji training program for one hour per day with four sessions per week.

**Assessment of proprioception.** Kaplan, Nixon, Reitz, Rindfleish, and Tucker, (1985) assessed knee joint position sense using a transparent calibrated goniometer. Using the contralateral knee as a reference, authors measured the test knee joint at  $15^{\circ}$ ,  $30^{\circ}$ , and  $70^{\circ}$ . They also tested the memory of ipsilateral proprioception by measuring knee angle after memorizing the target angle for a short duration. Goble (2010) suggested, either the ipsilateral or contralateral limb should be selected based on the cognitive status of the participant (as memory and inter hemispheric connections are two main determinants). The author also reported the effect of hand dominance on proprioception; right hand dominant individuals are good at proprioceptive acuity with the left hand due to right cerebral hemisphere control. The proprioceptive inputs from our extremities are processed in the right cerebral hemisphere, as evident in individuals with right brain injuries demonstrating pronounced proprioception deficit. Based on the Edinburgh Handedness Inventory, it is estimated that 90% of the population is right handed. Also the dominant limb is guided by visual support whereas the non dominant limb relies mostly on proprioceptive inputs. This concept is applicable to the lower extremities too (Naito et al., 2007). Active positioning of the limb to the reference

position by the participant reduces the error rate.

Liu et al., (2012) studied the effects of Taiji versus a proprioception exercise program on neuromuscular function of the ankle in 60 elderly participants. The authors used joint position matching ability to test ankle joint proprioception at different angles. A footplate attached to a dynamometer moved the ankle into eversion and inversion passively with a speed of  $1^{\circ}$  per second. The examiner first passively moved the ankle into full inversion or eversion. Thereafter, the ankle joint was positioned in the reference angle for 10 seconds, and then moved to complete ranges of inversion or eversion again. Then the footplate driven by dynamometer moved the ankle joint. The blindfolded participant was instructed to press the handheld button on perceiving the reference position (Liu et al., 2012). Xu, Hong, Li, and Chan (2004), assessed ankle and knee joint kinaesthesia (threshold to detection of passive motion) using a custom made device, which moved the joint at a speed of  $0.4^{\circ}$  per second. The participant pressed a hand held button at the point when he/she felt the movement on the test joint. A similar method of measuring proprioception (threshold to detection of passive movement) was utilized by Sharma, Pai, Holtkamp, and Rymer (1997). They devised an apparatus with a stepper motor, linkage system, and a transmission system. This apparatus provided computer controlled knee angular motion at  $0.3^{\circ}$  per second. The participant pressed the button when he/she perceived the movement. The angular displacement between the starting position and the position at which the button was pressed was calculated.

Kiran, Carlson, Medrano, and Smith (2010) studied the correlation between electrogoniometer, 2D video analysis, and an isokinetic dynamometer measurement of joint position sense in 30 active college students. They evaluated the knee joint position

sense in sitting at three different angles ( $15^0$ ,  $30^0$ , and  $45^0$ ) using all three measures. However, in standing the isokinetic dynamometer was not feasible so only 2D video and electrogoniometer analysis were used. The authors reported, excellent correlation ( $r=0.96$ ) between electrogoniometer and 2D video analysis in standing. The correlation was good to excellent ( $r= 0.78$ ) between isokinetic dynamometer and electrogoniometer analysis in sitting; and fair to good correlation was observed between 2D video analysis and electrogoniometer ( $r= 0.55$ ) / isokinetic dynamometer ( $0.52$ ) analysis.

***Benefits of Taiji on ankle proprioception in older adults.*** Taiji also known as tai chi, taichiquan, or taiqi is a form of mind body exercise originating from ancient China. The word “tai” means “big” or “great”, while “chi” means “the ultimate energy”. Taiji is based on the concepts of “Yin-Yang”. According to Chinese philosophy, Yin and Yang are two ultimate opposing, and interdependent forces; the interactions between Yin and Yang are proposed to make the universe and humans function energetically. Taiji is practiced widely as a slow, rhythmic, gentle, and coordinated form of exercise. It is mainly classified into five styles based on the evolutionary modifications by different masters. Five main styles are Chen, Yang, Wu, Hao, and Sun (Chang et al., 2010). Each style has a unique characteristic movement pattern but shares the same philosophy and idea of ultimate energy.

Taiji emphasizes breathing techniques coordinated with movement patterns. It is focused on complete weight shifts, centering the balance, and relaxing the muscles. Taiji 6 form qigong is a basic style of taichiquan, which is widely popular in Northwestern Ontario, Canada. It emphasizes the coordination of mind and body, is easy to perform, and acceptable among seniors.

### **Research Problem**

Falls in the elderly are attributed to poor postural adaptation, and weak anticipatory postural reactions. Considering the strong relationship between falls in the elderly and declining proprioception (Kaplan, Nixon, Reitz, Rindfleish, & Tucker, 1985; Mion et al., 1989; Petrella, Lattanzio, & Nelson, 1997; Ribeiro & Oliveira, 2007), it is imperative to implement exercise programs to minimize the risk of falls by improving elderly proprioception. One avenue is to implement individual strength, balance, and proprioceptive training sessions in fall prevention and injury reduction for older adults. This approach, however, is not always feasible practically and financially. Furthermore, most of the rehabilitation programs are disease specific, and require specialized set ups with trained professionals. Based on these concerns, there is a need to design a safe, community based, easily adaptable, and popular exercise program to maximize the functional independence of older adults and, therefore, minimize the risk of falling.

One solution to minimize falls in the elderly is by using regular Taiji practice. Taiji improves strength, postural control, flexibility, and endurance in older adults (Hong, Li, & Robinson, 2000; Lan, Lai, Chen, & Wong, 2000; Lu, Hui-Chan, & Tsang, 2012; Wolf et al., 1996). Taiji may also improve the psychological well being of the participants. This effect is considered to be an important factor related to exercise compliance. Taiji is also considered the intervention of choice in older adults due to its low velocity, low impact, multi directional smooth movements, and coordinated breathing pattern (Liu et al., 2012). This type of exercise is safe to execute and has enduring effects on the overall health of the older adults.

Taiji has also been found to improve proprioception by morphologically altering

the cortical mass and increased muscle spindle function through increased gamma activity (Tsang & Hui-Chan, 2003). Taiji practitioners master the art of slow and graceful movement, which is the key to gain strength at varying joint angles and, therefore, improve the proprioception along with postural control and postural adaptation (Jacobson, Chen, Cashel, & Guerrero, 1997; Xian, Qing, & Hong, 2008). Derived from this notion, this study will evaluate the proprioception, functional strength and mobility, and postural adaptation of older adults after a 10-week Taiji intervention.

The question driving this study is: What is the effect of a 10-week Taiji training program on ankle proprioception, functional strength of the lower extremities, functional mobility and postural adaptation in older adults as a possible avenue to reduce falls?

### **Hypotheses**

A. There will be significant differences in ankle proprioception in older adults between the control group and Taiji training group after receiving 10-weeks of the intervention. The Taiji training group will demonstrate improvements in the sense of perceiving joint position and threshold to detect passive movement on the proprioception assessment.

B. During post testing, the extent of the effects of 10-week Taiji training intervention on functional strength of the lower extremities in older adults will show significant differences between the control and Taiji training group. The participants in the Taiji group will exhibit improved strength of the lower extremities which will be evident by the increased number of chair rises performed after Taiji training.

C. There will be a significant difference in functional mobility in older adults between the control group and Taiji training group after 10-weeks of the intervention.

The Taiji training group will demonstrate better mobility and functional balance assessed via the ATGUG. Participants in the Taiji group will take less time to complete the ATGUG Test.

D. During post testing, the 10-week Taiji training group will have significant improvements in postural control compared to the control group. The Taiji training group will exhibit decreased sway area, path length, and AP and ML sway on the force plate measures.

E. There will be a negative relationship between the quiet standing score and the balance space score in the Taiji training group. After 10-weeks of Taiji training, participants in the Taiji training group will demonstrate increased sway area, path length anteroposterior and mediolateral sway in the balance space task on the force plate measures in contrast to decreased sway area, path length, anteroposterior and mediolateral sway in quiet standing.

### **Objective of the Research**

Due to the high incidence of fall induced morbidity, mortality, and frailty, falls are a serious health problem in Canada. Specifically, the effect of falls on quality of life, economic status, and increased suffering associated with complications are beyond imagination. The purpose of this study was to determine the benefits of a 10-week Taiji training program in reducing the fall risk by assessing change in ankle joint proprioception, functional strength and mobility and postural adaptation in elderly participants in Thunder Bay.

### **Significance of this Study**

This study shall benefit the elderly population in preventing falls and improving confidence to ambulate. It will improve the functional independence of the participants, promote sense of well-being and encourage active participation of older adults on a long term basis. Taiji is also known for its psychological benefits and it also increases longevity. It will also facilitate future research on Taiji and promote its importance in healthy living.

### **Method**

#### **Pilot Study**

A pilot study was conducted to determine the suitability and feasibility of tasks and to investigate the appropriateness of the dependent measures. It was helpful in investigating the mechanism of the proprioception testing device and developing a protocol for the main study.

**Inclusion criteria for participants for pilot study.** After approval from the ethics review board of Lakehead University, 23 participants (14 males, 9 females) were recruited from Lakehead University through convenient sampling. All participants included in the sample were healthy with a mean age of 29 years ( $SD = 10.13$  years).

An information session was conducted after recruitment. This session was intended to further explain the study protocol, and potential benefits of the study. Before beginning the initial assessment, participants were instructed to read the information cover letter and sign the consent form (see Appendix A).

**Exclusion criteria.** Participants were excluded if they had any of the following impairments:

- A clinically established dementia or cognitive decline that prevented understanding simple instructions.
- A progressive neurological disease (e.g., Parkinson's disease).
- A preexisting severe lower extremity pathology, neurological disorder, or balance difficulty that prevented standing for the testing procedures with or without the aid of an assistive device (e.g., osteoarthritis, vertigo, dizziness, stroke, or epilepsy).
- Any acute health condition (e.g., heart disease, uncontrolled angina, chronic obstructive pulmonary disease, or osteoporosis) that would preclude participation in a Taiji program.
- Or current engagement in active Taiji practice.

**Instruments for pilot study.** The following instruments were used for measuring ankle proprioception:

***Proprioception testing device.*** A mechanical device with a dynamic foot plate, powered by an actuator motor, designed to move in either direction (ankle plantar flexion or dorsiflexion). This device was designed such that the motor is not visible (masked in a box) in order to elicit natural perceptions of the participant. A linear actuator motor is attached to the foot plate resting on an axle. It was also equipped with a potentiometer, connected to Power Lab unit via an analog to digital converter to measure the angle of the platform. The device was connected to a handheld switch, operated by the participant, to signal the perception of passive motion.

***Digital inclinometer android app.*** An android mobile phone application was used to measure angle of tilt with respect to the horizontal surface. It was used to calibrate and



measure the angle formed by the proprioception measuring device (MacIntyre, Recknor, & Recknor, 2014).

**Procedure for proprioception assessment.** Proprioception was measured using a proprietary device designed in the School of Kinesiology at Lakehead University. The footplate was set at  $0^{\circ}$  prior to each trial, and the speed was gradually increased up to  $0.4^{\circ}$  per second to move the platform in the desired direction of plantarflexion or dorsiflexion. A potentiometer was connected to the actuator to provide the angle measure of the footplate in reference to the ground (see Appendix B).

The participant was advised to stand on the foot plate of the proprioception measuring device to detect the passive movement threshold at the ankle joint. There was a demonstration trial in the forward direction, to enable each participant to understand the test. During this trial the participant could see the movement and hear the sound of the actuator motor. This demonstration trial was followed by one forward (plantarflexion) and one backward (dorsiflexion) test trial. The participant was blindfolded with an eye cover and provided with head phones playing white noise to eliminate both visual and auditory stimuli. After testing two participants, we changed the protocol to give participants adequate time to learn the task.

In the new protocol including the demonstration trial, four practice trials (two forward and two backward) were incorporated to enable learning the task along with four test trials to test the learning effect (i.e., total of nine trials). After each trial, the participant stepped off the foot plate so the angle could be reset to  $0^{\circ}$ . During the test trials, participants were not informed about the direction in which the plate would move. To randomize the sequence of direction and start time, each participant chose a unique

direction, and a set of four different delay times for starting the movement (2, 5, 7, and 9 seconds) from a set of cards. As the platform started and speed gradually increased up to the highest limit of 0.4<sup>0</sup> per second, the participant's task was to sense the moving platform through the ankle joint and press the switch. The difference between the start and stop positions of the platform was calculated by measuring the difference between the starting joint angle and the stopping joint angle. The data collected from nine trials were analyzed. The participants were instructed to report any discomfort during the process.

**Analysis.** After completion of the assessment procedure, the collected data were organized and the feasibility of the method analyzed. Consistency across replications of the test in relation to angular displacement and speed was computed using ICC correlation for the four practice trial scores obtained during the test procedure using the Statistical Package for Social Sciences version 20 (SPSS Inc., Chicago, IL).

**Results of pilot study.** ICC coefficients displayed acceptable consistency among angular displacement and speed measures between trial one and trial two (see Table 1).

Table 1.

*Internal reliability of proprioception test while forward and backward practice trials.*

DV	ICC Coefficient
Forward angle (degrees)	.79
Forward speed (degrees/second)	.81
Backward angle (degrees)	.69
Backward speed (degrees/second)	.57

From the pilot study results, it is quite evident that the forward angle and forward

speed are within the acceptable limit which suggests consistency between two trials for these variable measures. For the backward angle and speed measures, however, the ICC scores were low. Intraclass correlation coefficient values above 0.75 represent acceptable reliability (Fleiss, 1986). It is implied from the ICC values that for backward angle and speed measures, the trials needed to be more consistent in order to be included in the analysis. Hence, for this protocol, backward angle and speed measures were not included due to lack of reliability evidence between trials. It was concluded, however, that this study was helpful in determining the assessment timing, efficiency of proprioception measurement device, consistency between trials, and failure or success of the design. The criteria for a successful study were met, and we proceeded with the main study with a minor change in the number of practice trials in the protocol. As our main study sample involved seniors, we increased to three forward and three backward practice trials to facilitate the learning process.

### **Main Study**

The main study determined the effect of a 10-week Taiji training program on ankle proprioception, functional strength of the lower extremities, functional mobility and postural adaptation in older adults. The following method was implemented:

**Research design.** This was a quasi experimental open non-randomized, two group, pre test post test design. The participants were conveniently assigned either to a Taiji or control group. Baseline testing was performed before the intervention. Participants in each group were aware of the group allocation and intervention. Both groups were reassessed at the end of the 10-week intervention.

**Participant recruitment.** After obtaining approval from Lakehead University's

Research Ethics Board, 34 participants were recruited from the community. Information posters were displayed in prominent locations across the city such as the 55 Plus Centre, Canada Games Complex, Athletic Club, and Herb Carroll 55 Plus Centre (see Appendix C).

**Recruitment procedure for main study.** After successful completion of the pilot study, the participants were recruited for the main study. Following recruitment, all the participants were invited for an orientation session, which was designed to promote a detailed understanding of this study. A consent form (see Appendix D) was acquired from all participants after providing the information cover letter (see Appendix E). Participants were also requested to complete the demographic information and fall questionnaire form (see Appendix F) and PAR-Q + form (see Appendix G). This form provided a detailed medical history and information on any associated problems or the need to seek a physician's approval for participation in the study. This information was helpful in ensuring the inclusion of participants in the study based on the inclusion criteria. Each participant completed a baseline assessment which included the postural control and adaptation assessment using force platform, proprioception assessment, functional strength and endurance assessment, and functional mobility assessment.

**Instruments.** All instruments used in the pilot study to measure proprioception were utilized in the main study. The following instruments were used to assess lower extremity functional strength and postural adaptation:

***Chair with straight back.*** A standard chair with a height of 17 inches was utilized for the 30-second chair rise test. The backrest was flat and did not contain armrests.

***Stop watch.*** A watch with lap and split time was used to determine the time taken

by the individual while performing the ATGUG test.

***Force platform.*** An Advanced Mechanical Technology forceplate (AMTI Inc.) with three forces ( $F_x$ ,  $F_y$ , and  $F_z$ ) and three moments ( $M_x$ ,  $M_y$ ,  $M_z$ ) mechanical platform was used to measure the COP and postural sway. Center of pressure and postural sway measures computed via AMTI BIOSOFT software were used to determine postural control and postural adaptation of the participants.

***Social validation survey.*** The survey consisted of a brief questionnaire based on personal experience about Taiji and its effect; it was completed by participants in the Taiji group (adapted from Allen, 2001). The questions consisted of both closed and open ended response types and allowed participants to choose negative, positive, or undecided responses (see Appendix H).

***Procedure for functional mobility assessment.*** The ATGUG Test was used to measure functional mobility. The participant was seated and asked on command to get up from the chair, walk a distance of three meters, turn around, and walk back to the chair and sit down. All of the components were timed and measured using a stop watch. This test measured the basic mobility of the participant. As all the components were timed, it was possible to measure changes in each function required to execute the tasks (rising, sitting, walking, and turning). In this way the task became more sensitive to changes in mobility (see Appendix I).

***Procedure for postural sway assessment.*** Postural sway was assessed to determine the postural control and postural adaptation of the individual. The force platform was connected to a computer, and displayed and recorded the vertical force, and AP and ML moment of force applied to the force plate. Measures of postural sway

including AP and ML sway, area of sway (AS), and path length (PL) were recorded during quiet standing with eyes open and closed protocols and with the balance space task.

During the pre assessment phase, the foot size of each participant was traced on a piece of paper and his or her weight was recorded while the participant stood barefoot on the platform. For quiet stance measures, the participant was requested to stand as still as he/she could for 20 seconds on the platform while looking straight at a marker located 10 feet away. This practice was followed by three trials completed with eyes open (EO) and three trials with eyes closed (EC). During the balance space (BS) task, each participant was requested to lean forward, backward, right, and left as far as possible while keeping the trunk straight and without lifting his/her toes or heels for a 20 second duration. Three trials of each stance were recorded. The mean of three trials of Area of Sway, Path Length, Medio Lateral Sway, and Antero Posterior Sway measures in each stance (Eyes Open, Eyes Closed and Balance Space) was utilized for analysis. An assistant was always present to assist/protect the participants during the instrumental assessments to ensure safety.

**Procedure for proprioception assessment.** Proprioception was assessed using the revised protocol from the pilot study. There was a demonstration trial, six practice trials (three forward, three backward), and four test trials with a random sequence and delay as mentioned in the pilot. Following the trials, we conducted a short interview with each participant to further explore their responses; since this was a new area of inquiry and a new piece of equipment, we wanted to see if they thought they were actually able to isolate and perceive movement at the ankle (proprioception). The following four

questions were asked:

1. Do you think there was a delay in responding to the platform movement?
2. Which direction did you detect more easily, forward or backward?
3. Did the direction cue help you in determining the platform movement?
4. Where did you feel the movement?

Data from these responses are provided in Appendix J.

**Procedure for functional strength assessment.** The 30-Second Chair Stand Test was implemented to test the functional strength of the lower extremities (Jones et al., 1999). The participant was asked to sit on a straight backed chair without arm rests. He/she was then instructed to get up and sit down repeatedly for 30 seconds. The total number of repetitions completed was recorded and used to determine functional strength (see Appendix K).

**Procedure for group allocation.** All participants in the main study underwent baseline assessment of proprioception, postural control and adaptation, functional strength, and functional mobility. After the assessment, participants were assigned to the experimental and control groups based on their preference. The participants in the experimental group participated in a Taiji qigong training program led by a trained Taiji trainer. This training was scheduled twice a week for 10-weeks. Participants in the control group were advised not to practice Taiji during the study period. All the participants in the control group were provided an opportunity of Taiji training after the study. After 10-weeks, a final assessment of postural control and adaptation, proprioception, functional strength, and functional mobility was conducted and the difference between baseline measures computed (see Appendix L).

## **Intervention**

After administering the initial assessments, the Taiji group completed the twice a week Taiji training for a total of 10 weeks. Taiji classes were conducted in the multipurpose laboratory at the School of Kinesiology, Lakehead University. The duration of the class was one hour including warm up and cool down. There were two sessions scheduled per week. An activity log was provided to each participant to record the Taiji and physical exercises he/she was engaged in during the study period (see Appendix M). Assessments were repeated after the 10-week intervention for both groups. All participants submitted a logbook of physical activity every two weeks.

Participants in the control group were encouraged to maintain their regular schedule of activities. An activity log was provided to each participant to record the physical exercises he/she was engaged in during the study period (see Appendix N). This activity log was collected from the participant at the end of each week. It was helpful to justify any changes later in the analysis. Each participant in the control group was offered Taiji practice after the waiting period of 10-weeks.

## **Data Analysis**

Preliminary data were organized and processed using SPSS software (Version 20). Descriptive statistics were calculated to determine the nature and variability of the participants' demographics, proprioception, functional strength, functional mobility, and postural sway measures. Intraclass correlation coefficient (ICC) was used to assess the reliability of the test trials. Three trials were recorded for each of the variables of the postural control, postural adaptation, and proprioception tests. Intraclass correlation coefficient helped us to determine the consistency between each trial. We did not analyze



the data for the four test trials for proprioception. Although all trials were completed, we observed during the assessment that the participants found the absence of cues from vision, hearing, start time, and direction too difficult and resorted to guessing (indicating movement of the plate when none had occurred).

The effect of independent variable i.e., Taiji training on the dependent variables i.e., angular displacement, repetitions, postural control and postural adaptation measures, and time taken in the ATGUG task was analyzed. A mixed factorial two way ANOVA having two levels of time (pre and post intervention) and two levels of group (Taiji and control) was conducted to examine the interaction effect between time and group for each of the dependent variables. Bonferroni correction was used to control the inflating variance due to conducting multiple ANOVA tests; reducing the probability of committing a type-1 error. Since three mixed factorial ANOVAs were conducted, the alpha level rejection criterion was reduced to 0.017 (.05/3).

The effect sizes were computed using partial eta squared to evaluate the strength of the interaction effect to reject the null hypothesis. Effect size was calculated as the ratio of the effect variance ( $SS_{\text{effect}}$ ) to the sum of effect and error variance ( $SS_{\text{effect}} + SS_{\text{error}}$ ). A value of 0.02 was considered a small effect; 0.13 a medium effect; and 0.26 a large effect, using partial eta square respectively (Cohen, 1988; Kotrlik & Williams, 2003). Where, small effect is something observed with a careful analysis, medium effect is visible to naked eyes and large effect is grossly perceptible (Cohen, 1988).

Intraclass correlation analyses were conducted to examine the relationship between post test and pre test scores of quiet standing in the Taiji training group post

intervention. Similarly, all the variables of balance space task, post test and pre test scores were also correlated using ICC. The significance level for the correlation was set at .05.

### **Limitations**

Delay in response time by the participant could be considered a potential limitation of this study. Proprioception in the ankle is sensed by the muscle spindles, and this information is conveyed to the right cortex via ascending tracts. The right cortex will process the information and transmit the impulse to the left motor area of the brain to confirm the sense of proprioception by sending an impulse to the hand which presses the switch. As a result, there will be a delay in the real perception of proprioception and its expression. As this is a natural result of aging, the delay may be lessened by training, however, we did not measure this possible delay.

During the proprioception test, the participant's response on the static platform could also be a major limitation in this study. Since participants were blindfolded, it is possible that perception of body sway during the eyes closed condition was misinterpreted as a moving platform (Błaszczyk, Hansen, & Lowe 1993). Another possible limitation of this study is the sample size. Due to the small sample size it is difficult to generalize the results to the larger population.

## **Results**

### **Participant Characteristics**

In this study 34 participants aged 57 to 79 years ( $M = 66.5$ ,  $SD = 4.94$ ) were recruited. Twenty-five were classified as fallers. The participants were conveniently assigned to either a Taiji ( $n=17$ ) or a control group ( $n=17$ ). We accepted a few

participants younger than 65 years of age due to participant interest in minimizing potential risks for falls. In this cross-over design, however, participants from both groups completed an initial assessment of postural control and postural adaptation, proprioception, functional mobility, and functional strength of the lower extremities. One participant from the Taiji group and one from the control group dropped out of the study after completing the initial assessment, due to time conflicts, leaving 16 participants in each group. All participants recruited in this study were highly enthusiastic. They represented a spectrum of people from different parts of the City of Thunder Bay. The average attendance for the entire Taiji training session was 87%. Six of the participants attended all 20 sessions. Two participants left the training midway; one after 8 sessions (due to arthritic symptoms) and the other after 10 sessions (due to personal issues). Demographic information and descriptive characteristics for all participants are reported in Table 2. Comparison of pre intervention assessment values revealed no significant differences between the two groups (see Appendix O).

Table 2.

*Comparison of means and standard deviations of participant demographics pre intervention.*

	Taiji group (n=16)	Control group (n=16)
	Mean (SD)	Mean (SD)
Age (years)	67.31 (4.84)	65.62 (5.04)
Weight (lbs)	162.10(31.09)	169.26 (37.59)
Height (cm)	161.88 (7.11)	161.81 (8.25)
Right Foot length (cm)	24.14 (1.00)	23.69 (1.44)
Right Foot width (cm)	9.11 (0.42)	9.01 (0.76)
Left Foot length (cm)	23.97 (1.12)	23.63 (1.37)
Left Foot width (cm)	9.35 (0.39)	8.95 (0.67)
Pre study Taiji experience (hrs)	10.00 (13.05)	7.5 (11.80)

### **Log Book Records for Taiji and Control Group**

Log book records for the two groups were calculated after 10-weeks. Sixteen participants completed the twenty sessions, or 282 hours, of Taiji at the Sander's Field House ( $M= 17$ ,  $SD = 3.5$ ). In addition to supervised practice, participants also practiced 193 hours of Taiji at home ( $M= 12$ ,  $SD = 9.4$ ) and 649 hours of other physical activity ( $M= 41$ ,  $SD = 18$ ). In contrast, the control group completed 943 hours of physical activity ( $M= 59$ ,  $SD = 21$ ). There was no significant difference observed in total number of hours of physical activity being performed by the two groups,  $t(30)= 1.63$ ,  $p= .11$ .

### Performance on Measures of Ankle Proprioception

Ankle proprioception was measured using threshold to detect passive motion at the ankle. For all variables, the lower score represents better proprioception. Means and standard deviations for all proprioception measures are presented in Table 3.

Table 3.

*Comparison of means and standard deviations of the proprioception measures from pre and post test for Taiji and control group.*

Group	Taiji Group (n=16)		Control Group (n=16)	
	Pre test mean (SD)	Post test mean (SD)	Pre test mean (SD)	Post test mean (SD)
Proprioception Variable				
Forward angle (degree)	.43 (.22)	.48(.32)	.35 (.14)	.46(.25)
Backward angle (degree)	.54 (.27)	.40* (.21)	.45 (.17)	.58* (.22)

\* $p \leq .05$

Consistency across replications using ICC correlation coefficients (three trials at the pre and post assessments) showed acceptable reliability of forward angle proprioception measures (see Appendix P). Based on the reliability measures across replications of the test, a composite score was computed by calculating the mean of three practice trials. When conducting the mixed factorial repeated measures ANOVA, the analysis revealed a significant interaction effect of time with a large effect size on the Taiji and control group in relation to proprioception backward angle, ( $F(1, 30) = 16.53$ ,  $p < .001$ ,  $\eta_p^2 = .36$ ). This result indicates improved capability of participants in the Taiji group to detect the backward tilting movement of the platform.

Figure 1 displays the estimated marginal means interaction effect of the group\*time for the backward angle.

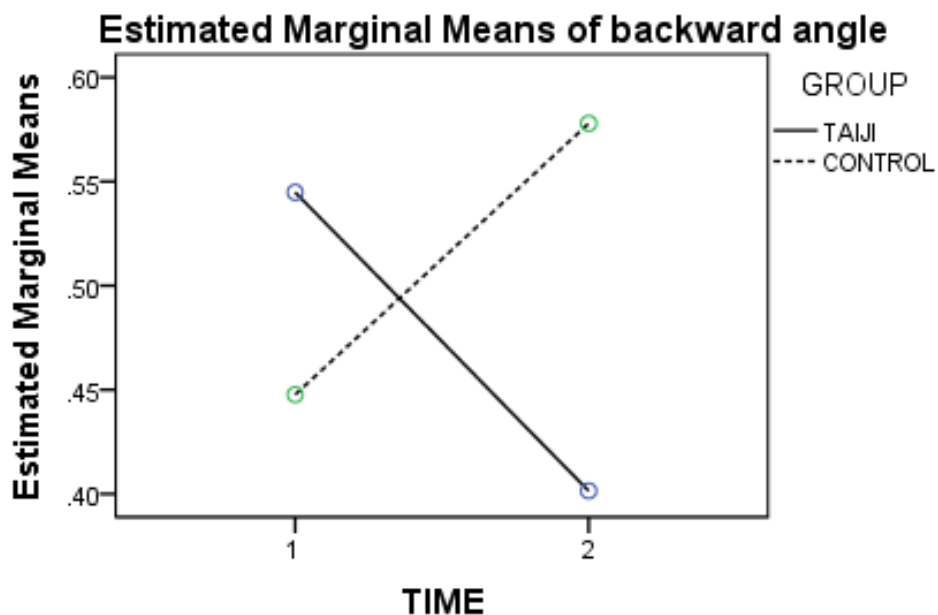

Figure 1. The interaction plot of Taiji and Control group from pre intervention (time 1) to post intervention (time 2). Assessment of measures of proprioception

### Post Proprioception Trials Interview

After proprioception testing, each participant in the Taiji group and control group answered four questions based on his/her experiences in completing the proprioception task and the responses were recorded and analyzed. When asked about any delay in responding to the platform movement, the majority of the participants from both groups reported that there was no delay in the reaction to platform movement. Some of the participants reported that they were not sure about the movement; hence they waited to feel and confirmed it with increased body lean. Similarly when asked about whether the direction cue helped them in determining the platform movement, 80% of the participants reported that they benefitted from the direction cue in determining the movement. When

asked about which direction they found easier to detect, 47% of participants reported that the backward direction was easier to determine compared to forward. Lastly, when questioned about where they felt the movement, 91% of participants reported that they felt the movement in and around their ankle joint.

### Performance on Measures of Functional Strength

The functional strength of the lower extremities was assessed using a 30-Second Chair Stand Test. More repetitions in this test represent better functional strength of the lower extremities. The mean and standard deviation for the 30-Second Chair Stand measures are shown in Table 4. One trial at each assessment time was executed.

Table 4.  
*Comparison of means and standard deviations of the 30-Second Stand Test measures from pre and post test for Taiji and control group.*

Group	Taiji Group (n=16)		Control Group (n=16)	
	Pre test mean (SD)	Post test mean (SD)	Pre test mean (SD)	Post test mean (SD)
Repetition	11.94 (2.46)	13.06* (2.08)	11.94 (2.77)	12.81* (2.51)

\* $p \leq .05$

The mixed factorial repeated measures ANOVA revealed no significant interaction effect for time\*group in relation to the number of repetitions when performing the 30-Second Chair Stand Test. However, when analyzing the main effect for time, there was a significant difference with a large effect size, between the pre and post test in relation to the number of repetitions, ( $F(1, 30) = 12.07, p < .002, \eta_p^2 = .29$ ). This result indicates that the mean number of repetitions was greater in both the Taiji and control

group at the post test ( $M = 13.06$ ,  $SD = 2.08$ ); ( $M = 12.81$ ,  $SD = 2.51$ ). The result of this test shows an improved performance in terms of repetition of getting up and sitting back down on a chair in participants of both groups. Moreover, analysis of the main effect for group yielded no significant difference.

### **Performance on Measures of Functional Mobility**

Functional mobility was evaluated using the ATGUG test. For all variables, a lower score represents greater mobility. Means and standard deviations for all the functional mobility measures are presented in Table 5.



Table 5.

*Comparison of means and standard deviations of the functional mobility measures between pre and post test for Taiji and control group.*

Functional Mobility Variable	Taiji Group (n=16)		Control Group (n=16)	
	Pre test mean (SD)	Post test mean (SD)	Pre test mean (SD)	Post test mean (SD)
ATGUG total time	7.82 (.99)	7.68 (1.32)	8.19 (1.57)	8.23 (1.76)
Time 1- rising from chair to 1 meter	1.71 (.28)	1.71 (.39)	1.64 (.23)	1.65 (.28)
Time 2- walking next two meters	1.37 (.25)	1.48 (.32)	1.37 (.28)	1.59* (.20)
Time 3- turning 360°	1.30 (.25)	1.38 (.24)	1.34 (.37)	1.23 (.22)
Time 4- walking back 3 meters	2.02 (.39)	2.25 (.51)	2.18 (.40)	2.56* (.66)
Time 5- turning and sitting on chair	.94 (.26)	0.59** (.14)	1.03 (.27)	0.57** (.13)

\* $p \leq .05$

\*\* $p \leq .001$

Consistency across replications using ICC correlation coefficients (two trials at the pre and post assessments) showed acceptable reliability of ATGUG time 2, ATGUG time 4, and ATGUG total time measures of the ATGUG (see Appendix Q). Based on the reliability measures across replications of the test, a composite score was computed by calculating the mean of three practice trials. The values of the ATGUG time 1, ATGUG time 3, and ATGUG time 5 for the Taiji group were used with caution, since the ICC coefficient was low for the Taiji group in the pre test assessments.

When applying the mixed factorial ANOVA, the analysis revealed no significant interaction effects with small effect size for time\*group in relation to the dependent variables; ATGUG total ( $F(1, 30) = .13, p = .72, \eta_p^2 = .00$ ); ATGUG time 1 ( $F(1, 30) = .00, p = .93, \eta_p^2 = .00$ ); ATGUG time 2 ( $F(1, 30) = .92, p = .34, \eta_p^2 = .02$ ); ATGUG time 3 ( $F(1, 30) = 1.95, p = .17, \eta_p^2 = .01$ ); ATGUG time 4 ( $F(1, 30) = .80, p = .38, \eta_p^2 = .02$ ); or ATGUG time 5 ( $F(1, 30) = 1.05, p = .31, \eta_p^2 = .02$ ). However, when analyzing the main effect for time (time1-time2), there was a significant difference with medium effect size between the pre and post assessments for ATGUG time 2 ( $F(1, 30) = 8.98, p = .005, \eta_p^2 = .23$ ); and significant difference with large effect size between the pre and post assessments for ATGUG time 4 ( $F(1, 30) = 15.56, p = .001, \eta_p^2 = .34$ ), indicating that the mean time taken by both groups increased. Although both groups decreased their gait speed, the scores of the control group contributed more to this main effect. For example, the mean score of ATGUG time 2 in the Taiji group during the pre test and post test was ( $M= 1.37, SD= .25$ ); ( $M= 1.48, SD= .32$ ), and for control group pre test and post test was ( $M= 1.37, SD= .28$ ); ( $M= 1.59, SD= .20$ ).

Similar, results were observed on analyzing the main effect for time (time 1-time 2); there was a significant difference with large effect size between the pre and post assessments on ATGUG time 5 ( $F(1, 30) = 55.76, p = .00, \eta_p^2 = .65$ ). This result indicates that the mean time taken by the participants in both the Taiji and control groups decreased ( $M=.59, SD= .14$ ); ( $M=.57, SD= .13$ ), and suggests a functional improvement

in ability to make 180<sup>0</sup> turns while walking. Analysis of main effect for group revealed no significant difference.

### **Performance on Measures of Postural Control and Postural Adaptation**

In both quiet standing (eyes open and closed) and the balance space tasks, the dependent variables were anteroposterior sway, mediolateral sway, area of sway, and path length. Lower values represent less sway or better postural control for the quiet standing with eyes open and eyes closed conditions, whereas, higher values indicate better postural adaptation in the balance space task. Means and standard deviations of the postural control and postural adaptation variables from both pre and post assessment are reported in Table 6.

Table 6.

*Comparison of the means and standard deviations of the postural control and postural adaptation measures between pre and post test for Taiji and control group.*

Group		Taiji group (n=16)		Control group (n=16)	
		Pre test mean (SD)	Post test mean (SD)	Pre test mean (SD)	Post test mean (SD)
Quiet Standing Eyes Open	AP (cm)	.40 (0.09)	.43 (0.09)	.40 (0.12)	.45 (0.13)
	ML (cm)	.30 (0.07)	.31 (0.09)	.32 (0.13)	.31 (0.07)
Quiet Standing Eyes Closed	AS (cm <sup>2</sup> )	.10 (0.03)	.11 (0.05)	.09 (0.04)	.10 (0.03)
	PL (cm)	6.15 (1.00)	6.19 (0.89)	6.00 (1.00)	6.22 (0.68)
Balance space task	AP (cm)	.52 (0.09)	.51 (0.10)	.51 (0.16)	.54 (0.17)
	ML (cm)	.33 (0.08)	.37 (0.12)	.32 (0.08)	.34 (0.08)
Balance space task	AS (cm <sup>2</sup> )	.13 (0.06)	.14 (0.08)	.12 (0.05)	.13 (0.06)
	PL (cm)	7.65 (1.63)	7.84 (1.75)	7.33 (1.49)	7.76 (1.58)
Balance space task	AP (cm)	2.88 (0.54)	2.84 (0.40)	2.81 (0.61)	2.81 (0.62)
	ML (cm)	2.67 (0.57)	2.76 (0.46)	2.91 (0.44)	2.75 (0.52)
Balance space task	AS (cm <sup>2</sup> )	7.29 (3.24)	7.63 (2.39)	7.27 (3.29)	7.35 (3.40)
	PL (cm)	21.15 (5.00)	21.83 (4.40)	21.72 (3.95)	21.14 (4.18)

Note: Lower scores represent better postural control for quiet standing with eyes open and eyes closed conditions. For balance space, the higher score represents better adaptation.

#### **Performance of COP measures in the quiet standing eyes open task.**

Consistency across replications using ICC correlation coefficients (three trials at the pre and post assessments) showed acceptable reliability for all COP measures in the eyes open task except for the post assessment of the control group on ML sway (see Appendix R). Based on the reliability measures across replications of the test, a composite score

was computed by calculating the mean of three practice trials. However, the values of anteroposterior sway, mediolateral sway, and area of sway are used with caution as ICC coefficients were low for the Taiji group pre test.

When applying the repeated measures mixed factorial ANOVAs, the results revealed no interaction effect with small effect size for time\*group for anteroposterior sway ( $F(1, 30) = .48, p = .49, \eta_p^2 = .01$ ); mediolateral sway ( $F(1, 30) = .38, p = .54, \eta_p^2 = .01$ ); path length ( $F(1, 30) = .72, p = .40, \eta_p^2 = .02$ ); and area of sway ( $F(1, 30) = .00, p = .94, \eta_p^2 = .00$ ). Moreover, analysis of the main effect for each individual factor (i.e., time and group) also yielded no significant difference. This result suggests no change in the postural control mechanism in the eyes open task.

**Performance of COP measures in quiet standing eyes closed.** Consistency across replications using ICC correlation coefficients (three trials at the pre and post assessments) showed acceptable reliability for all COP measures in the eyes closed task except for the pre assessment of the Taiji group on anteroposterior sway (see Appendix S). Based on the reliability measures across replications of the test, a composite score was computed by calculating the mean of three practice trials. The values of AP sway for the Taiji group are used with caution.

When conducting the mixed factorial ANOVA, there was no interaction effect with small effect size for time\*group for anteroposterior sway ( $F(1, 30) = 1.43, p = .24, \eta_p^2 = .02$ ); path length ( $F(1, 30) = .51, p = .48, \eta_p^2 = .01$ ); area of sway ( $F(1, 30) = .15, p = .70, \eta_p^2 = .00$ ); or mediolateral sway ( $F(1, 30) = .76, p = .39, \eta_p^2 = .02$ ). Moreover, analysis

of the main effect for each individual factor (i.e., time and group) also yielded no significant difference. This result suggests no change in the postural control mechanism in the eyes closed task.

**Performance of COP measures on the balance space task.** Consistency across replications using ICC correlation coefficients (three trials at the pre and post assessments) showed acceptable reliability for all COP measures in the balance space task (see Appendix T). Based on the reliability measures across replications of the test, a composite score was computed by calculating the mean of three practice trials.

When applying the repeated measures two-way ANOVA there was no interaction effect with small effect size for time\*group for anteroposterior sway ( $F(1, 30) = .06, p = .81, \eta_p^2 = .00$ ); path length ( $F(1, 30) = .90, p = .35, \eta_p^2 = .02$ ); area of sway ( $F(1, 30) = .11, p = .74, \eta_p^2 = .00$ ); or mediolateral sway ( $F(1, 30) = 3.21, p = .08, \eta_p^2 = .02$ ). Moreover, analysis of the main effect for each individual factor (i.e., time and group) also yielded no significant difference. This result suggests no change in the postural adaptation mechanism (i.e., the ability to approach the stability boundaries by leaning).

### **Correlation of Postural Control and Postural Adaptation Score**

Intraclass correlation was used to examine the correlation between post intervention and pre intervention scores of quiet standing eyes open measures of all four variables i.e., PL, AS, ML, and AP sway. There was a strong positive correlation between pre post quiet standing eyes open path length, .82 indicated by high strength of agreement. There was a moderate positive correlation between pre post quiet standing

eyes open area of sway, .46; anteroposterior sway, .37; and mediolateral sway, .61 as indicated by their respective medium strength of agreement.

Similar ICC was calculated to estimate the correlation between post intervention and pre intervention scores of balance space measures of all four variables i.e., PL, AS, ML, and AP sway. There was a moderate positive correlation between pre post balance space area of sway, .63; anteroposterior sway, .53; mediolateral sway, .57 and path length, .60 as indicated by their respective medium strength of agreement.

### **Social Validation Survey**

To estimate experiential factors relating to Taiji, a social validation survey was administered to the Taiji group. This survey helped in providing qualitative data about the intervention and its effect on the social life of the participants. All the participants in the Taiji group completed the questionnaire during the post assessment session. All participants reported that their lives had become better after joining the Taiji sessions. One participant said *“I am more aware of movement of my body and in being so have decreased the number of falls I have had in the last month”*.

Five participants reported that they changed their exercise habits, and more indulged in Taiji and other physical activities during the Taiji training. For example, *“I started walking at the same time I am more active at home. I have been a couch potato for years”*. Fifteen of the 16 said they were satisfied with the program and the instructor and would like to participate in Taiji classes again *“Because I am so enjoying the*

*participation by my own self it will be helpful to my friend also*". All participants reported that they would positively recommend this program to their friends.

Four participants in the Taiji group had treatment and medication changes during the class session. Among them, one had a fibromyalgia flare up, one received antihypertensive and thyroid medications, and another received medication for restless leg syndrome. One participant received physiotherapy treatment for carpal tunnel syndrome. These changes in medication and status did not affect the attendance in the Taiji sessions. Almost all of the participants reported that Taiji was a relaxing exercise and had a calming effect. One participant said "*after doing Taiji, I am highly motivated, better organized, calm, and Taiji also enabled me to slow my pace, relax, and be aware of my body*".

All participants indicated an improvement in balance post Taiji practice sessions. Some of the feelings expressed by participants are quoted here; "*My standing is better and I can pin point contact points..., Movement has improved, balance greatly improved and muscle ache and pain lessened..., It feels like a positive ongoing life resource to maintain optimal function, and balance mentally/physically*". All the participants commented favourably on the social benefits of Taiji and being a part of group and, overall, they enjoyed the 10-weeks.



## **Discussion**

This study evaluated the ankle proprioception, functional strength, functional mobility, and postural control and adaptation of older adults with fall risk after a 10-week Taiji Quan intervention using an experimental design, with a Taiji group and a control group. It was hypothesized that Taiji would have a positive impact on these variables. Results from this study confirm that a 10-week Taiji training has significant impact on ankle joint movement sense or proprioception. These findings are similar to the randomized controlled trial conducted by Liu et al., (2012) on ankle joint position sense, irrespective of the method used for proprioception measurement. Results from this study are discussed in accordance with the hypotheses.

### **The Effect of Taiji on Ankle Proprioception**

Although many studies (Iwamoto et al., 2009; Kelley, 2013; Lord et al., 2005; Zettergren, Moriarty, & Zabel, 2005) have indicated that adoption of regular physical activity can attenuate the age related decline in physiological status, few have examined the effect of exercise, especially recreational exercise like Taiji, on the ankle proprioception of older adults (Liu et al., 2012; Xian, Qing, & Hong, 2008; Xu, Hong, & Chan, 2004). Many forms of Taiji are executed in either single-stance weight bearing or double-stance weight bearing which further require pivoting the whole body or twisting the trunk (Jacobson, Ho-Cheng, Cashel, & Guerrero, 1997). All forms require coordination of the body and limbs; highly dependent on postural adaptation, postural control, rhythmic breathing and synchronized muscle contraction (Greenspan, Wolf, Kelley, & O'Grady, 2007). In keeping with the hypothesis, results from this study

revealed that regular practice of Taiji for 10-weeks, improved the proprioception of ankle joint backward angle.

Taiji training also imparts psychological benefits such as reducing anxiety, decreasing depression, enhancing mood in older adults and improved well being (Wang et al., 2010). The present study supports these beneficial effects of Taiji based on the findings on well-being as estimated by the Social Validation Survey. In Chinese philosophy Yin and Yang are two ultimate opposing, and interdependent forces; the interactions between Yin and Yang are proposed to make the universe and humans function energetically (Chang et al., 2010). All participants in the Taiji group commented favorably on improved functional independence and better performance in their daily activity log sheet.

Xu, Hong, and Chan (2004) reported that long term Taiji practitioners are sensitive to a small amount of movement at the joints due to improved body image because Taiji practice involves slow, graceful body movements with gradual reduction in the BOS. Similarly, Lan, Lai, and Chen (2002) commented on effectiveness of Taiji intervention in improving the ankle joint position and movement sense. Results from the present study revealed that the ankle proprioceptors are significantly more sensitive to dorsiflexion after 10-weeks of Taiji training. While a significant deterioration of the same magnitude was observed in the control group.

Sachs (2008), in his review article commented on the declining proprioceptive acuity in older adults due to decreasing levels of hormones such as testosterone, growth hormone, and insulin-like growth factors along with the reduced number of satellite cells

in muscles. Similarly, Ghez, Gordon, and Ghilardi, (1995) showed delayed movement onset and inaccurate trajectory formation in patients with proprioceptive loss. The findings of the present study on ankle proprioception in the control group mirror this deterioration in proprioception.

Although, proprioception measurement in several studies (Liu et al., 2012; Xian, Qing, & Hong, 2008; Xu, Hong, & Chan, 2004) is conducted either in sitting or lying, in the present study the researcher used a standing platform. The concept of using a standing platform originated from an attempt to mimic fall oriented positions which were recently observed in older adults i.e., standing and walking by Robinovitch et al. (2013). To ensure the reliability of the device a pilot study was conducted and ICC values were calculated. Angle calibration of the device was done using a cell phone app and potentiometer connected to Power Lab 26T. Evidence of the face validity for the proprioception measurement device was confirmed through a questionnaire based on the participant's experience. The results of the questionnaire lead us to believe that the inferences made from the device measures had some evidence of validity and that further inquiry with this equipment is warranted.

The effect size for the interaction effect indicated that Taiji training accounted for a relatively large proportion of variance in the dependent variable score i.e., ankle joint proprioception measurement. This result supports the effectiveness of Taiji in improving ankle joint backward angle proprioception. If the 10-weeks intervention can provide this effect size, regular practice may be more beneficial and have enduring effects. Future

studies should be focused on the duration of Taiji and comparison of short duration practice compared to long duration practice effects in older adults.

Recall from the analysis of hours of physical activity in both groups; there was no significant difference between Taiji and control group for total hours of physical activity. It can be implied from the results that specific activity, i.e., Taiji performed for equivalent duration, can impart more beneficial effects compared to various other physical activities (Gillespie et al., 2012).

### **The Effect of Taiji on Functional Strength and Endurance of Lower Extremities**

The present study used the 30-Second Chair Stand Test to measure the functional strength of the lower extremities in older adults. In keeping with the hypothesis, the present study revealed that the Taiji intervention enhanced the functional strength and endurance of the lower extremities as evidenced by the statistically significant improvement in the number of repetitions completed. Although there was significant improvement in both groups after 10-weeks, the improvement in the Taiji group can be explained by the intervention effect and the additional physical activities. On the other hand, improvements in the control group could probably be due to high levels of physical activity. Participants engaged in exercises at the intensity suggested by the Canadian Society for Exercise Physiology (CSEP) (i.e., 150 minutes of moderate to vigorous aerobic physical activity per week) as reported in their weekly logbook (Hovanec, Sawant, Overend, Petrella, & Vandervoort, 2012).

Taiji exercises were performed in standing which may be a possible explanation for this improved strength. Taiji training demands controlled knee flexion and extension requiring concentric and eccentric contraction of the muscles around the knee joint. Most of the forms are performed in slight knee flexion which enhances eccentric strength of knee extensors (Vandervoort, Kramer, & Wharram, 1989). The warm up and cool down exercises were designed to facilitate muscle strength and prevent injury. These effects are consistent with the findings reported by Lu, Hui- Chan and Tsang (2012).

The effect size for the main effect of time indicated that, regular physical activity of moderate to vigorous intensity for ten weeks, accounted for a relatively large proportion of variance in the dependent variable score i.e., 30-Second Chair Stand Test score. This signifies that moderate to vigorous physical activity is beneficial in retaining the lower extremity strength and endurance. However, the only difference in the activities between the two groups is the additional Taiji practice. It can be argued that both groups were active and the strength gain from gentle Taiji practice was similar to the other physical activities practiced at moderate to vigorous levels.

### **The Effect of Taiji on Functional Mobility**

The ATGUG Test was used to measure the functional mobility of older adults, where lower scores represent better functional mobility. This test measures six phases; each phase signifies different components of functional mobility. In line with the research hypothesis, a significant decrease in time taken by the participants was observed in the Taiji group for turning and sitting back on the chair (ATGUG 5). The effect size for the main effect of time indicated that, regular physical activity of moderate to vigorous

intensity for ten weeks, accounted for a relatively large proportion of variance in the dependent variable score i.e., ATGUG 5 score. This improvement is attributed to the increased capability to turn and twist around the foot and ankle, emphasizing the refinement of reflexes. Jacobson, Ho-Cheng, Cashel, and Guerrero, 1997 in their study reported that, Taiji practice involves pivoting the whole body and twisting the trunk. It can be implied from the results that participants in the Taiji group have improved their skills to make sharp turns and helped them to effectively switch between standing to the sitting posture. However, a significant decrease in the time taken by the participants in the control group in the same task was also observed. It can be argued that the participants in the control group are involved in physical activities involving repeated sitting and standing, which makes them more efficient in this task (Park, Shoemaker, & Haub, 2008). No significant difference was observed in the total ATGUG time.

According to Hypothesis C, it was expected that the Taiji group would perform better than the control group in walking. Although participants in the Taiji group demonstrated decreased walking speed, the control group showed significant declines in both walking measures, i.e., time for walking two metres (ATGUG time2) and walking back 3 metres (ATGUG time4). This change may have been due to declining proprioception with time leading to incorrect weight shift pattern between the limbs (Robinovitch et al., 2013). It can also be argued that the control group was performing better on the 30-Second Chair Stand Test but not on the ATGUG 2 and ATGUG 4 test because strength is only one of the factors in maintaining optimum mobility. Lack of joint position and joint movement sense because of age related changes in proprioceptive

inputs from the joint (Liu, Eriksson, Thornell, & Pedrosa-Domellof, 2005) might have contributed to the delayed mobility in the task; as joint position sense and joint movement sense are vital for the execution of smooth and coordinated movement and balance control (Tsang & Hui-Chan, 2003). The effect size for the main effect of time indicated that, regular physical activity of moderate to vigorous intensity for ten weeks, accounted for a relatively medium proportion of variance in the dependent variable score i.e., ATGUG 2 score and relatively large proportion of variance in ATGUG 4 score. Although both groups showed a decline in walking speed, the Taiji group performed comparatively better than the control group. The Taiji group might have improved the gait pattern and infused the confidence to ambulate in a slow and consistent manner as they learned it from Taiji practice.

### **The Effect of Taiji on Postural Control and Postural Adaptation**

An increase in body sway in quiet upright standing is considered to be an indicator of poor balance (Ferne, Gryfee, Holliday, & Llewellyn, 1982). Increased sway can be attributed to the secondary effects of aging as declining muscle strength, poor vision, delayed reflexes and incoordination (Woollacott, Shumway-Cook, & Nashner, 1986). Results from this study revealed no change in the Taiji group in any of the variables on the posturography test, hence the hypothesis was rejected.

Posturography is highly sensitive to the task specific performance. Any cognitive or physical impairment may have an effect on performance sensitivity. All participants in the current study ranged from 57-79 years, and were physically active. This relative fitness may have had an impact on the overall scores for postural control and postural

adaptation. As the participants are active, their scores on postural control and postural adaptation would most likely require many more hours of Taiji to achieve any significant improvement (Sattin, Easley, Wolf, Chen, & Kutner, 2005; Li et al., 2005). Alternatively it can be argued that participants executed the assigned task within their perceived functional capabilities rather than their actual functional limits. It is possible, that performing to challenge their stability limits was not the way that they perceived or executed this task.

According to hypothesis E, it was expected that there would be a negative correlation between post intervention and pre intervention scores in quiet standing eyes open variables and it was also anticipated that there would be a positive correlation between post intervention and pre intervention scores in balance space variables. This hypothesis is partially rejected as the estimates of quiet standing variables are depicting positive correlation. This implies that participants are showing increased sway for quiet standing eyes open and balance space tasks, which can be due to adaptation to excessive sway and ability to maintain the stance without falling. Positive correlation results in the present study are in line with the research by Allen and Taylor (2001).

### **Summary**

From the analysis of proprioception, functional mobility, lower extremity strength and postural control/postural adaptation variables at pre and post intervention, the 10-week Taiji training appears to have a positive impact on proprioception, functional mobility, and lower extremity strength. Variables with significant difference and large effect size include proprioception: backward angle; lower extremity strength and



functional mobility variable: Time 5- turning and sitting on chair (ATGUG 5) and Time 4- walking back 3 metres (ATGUG 4). Functional mobility variables: Time 2- walking next two metres (ATGUG 2) showed medium effect size with significant difference. Participants self perceived benefits as evident through the survey questionnaire highly support the Taiji intervention for this age group.

### **Limitations and Recommendations**

It is clear that additional studies are needed in order to further examine the effects of Taiji intervention in older adults. The small sample size and lack of male participants limit the generalizability of this study. The generalizability of this study to the population of older women, however, is enhanced by the large effect size reported for proprioception backward angle and lower extremity functional strength. A more heterogeneous group of participants including males from different regions and implementation of a randomized control trial may be an alternative to increase the external validity in future studies. Taiji training could also be increased to three or four times per week to gain more beneficial effects from this holistic exercise. The device used for proprioception should be modified to provide uniform speed across trials, and include simultaneous measure of postural sway, for example, by placing the device on a force platform or recording electromyographic (EMG) signals. This device can be used in future research, after providing more evidence of accuracy and precision by computing Root Mean Square (RMS) Error measurement. RMS error will calculate the magnitude of error between observed values and predicted values.

## References

- Agostini, J. V., Baker, D. I., & Bogardus, S. T. (2001). Prevention of falls in hospitalized and institutionalized older people. *Evidence Report/ Technology Assessment Number 211, Making Health Care Safer II: An updated critical analysis of the evidence for patient safety practices.*
- Allen, D., & Taylor, J. (2001). The effects of tai chi on balance and mobility in older women who are at various risk levels for falls. *Poster presented at the International Symposium on Adapted Physical Activity, Vienna, Austria.*
- Al-Aama, T. (2011). Falls in the elderly prevention and spectrum. *Can.Fam.Physician, 57, 771-776.*
- Arfken, C. L., Lach, H. W., Birge, S. J., & Miller, J. P. (1994). The prevalence and correlates of fear of falling in elderly persons living in the community. *American Journal of Public Health, 84, 565-570.*
- Baloh, R. W., Ying, S. H., & Jacobson, K. M. (2003). A longitudinal study of gait and balance dysfunction in normal older people. *Archives of Neurology, 60, 835-9.*
- Berg, K.O., Wood-Dauphinee, S.L., Williams, J.I., & Gayton, D. (1989). Measuring balance in elderly: preliminary development of an instrument. *Physiotherapy Canada, 41, 304-311*
- Blake, A. J., Morgan, K., Bendall, M. J., Dallosso, H., Ebrahim, S. B., Arie, T. H., Fentem, P. H., & Bassey, E. J. (1988). Falls by elderly people at home: Prevalence and associated factors. *Age and Ageing, 17, 365-372.*
- Blaszczyk, J.W., Hansen, P.D., & Lowe, D.L. (1993). Postural sway and perception of the upright stance stability borders. *Perception, 22, 1333-1341.*

- Boelens, C., Hekman, E. E., & Verkerke, G. J. (2013). Risk factors for fall of older citizens. *Technology and Health care, 21*, 521-533.
- Brown, K. D., Koziol, J. A., & Lotz, M. (2007). A yoga-based exercise program to reduce the risk of falls in seniors: A pilot and feasibility study. *Journal of Alternative and Complementary Medicine, 14*, 454-457.
- Cavanillas, A. B., Ruiz, F. P., Moleon, J. J., Alonso, C. P., & Vargas, R. G. (2000). Risk factors in falls among the elderly according to extrinsic and intrinsic precipitating causes. *European Journal of Epidemiology, 16*, 849-859.
- Chang, Y. K., Nien, Y. H., Tsai, C. L., & Etnier, J. L. (2010). Physical activity and cognition in older adults: The potential of Tai Chi Chuan. *Journal of Aging and Physical Activity, 18*, 451-72.
- Christou, E. A., & Carlton, L. G. (2001). Old adults exhibit greater motor unit variability than young adults only during rapid discrete isometric contractions. *Journal of Gerontology: Biological Sciences, 56A*, B524-B532.
- Cohen, J. (1988). *Statistical power analysis for the behavioural sciences* (2<sup>nd</sup> ed.). New Jersey: Lawrence Erlbaum Associates.
- Costello, E., & Edelstein, J. E. (2008). Updates on falls prevention for community-dwelling older adults; review of single and multifactorial intervention programs. *Journal of Rehabilitative Research and Development, 45*, 1135-52.
- Dishman, R. K., Sallis, J. F., & Orenstein, D. R. (1985). The determinants of physical activity. *Public Health Report, 100*, 158-171.
- Djaldetti, R., Lorberboym, M., & Melamed, E. (2006). Primary postural instability: a cause of recurrent sudden falls in the elderly. *Neuroscience, 27*, 412-416.

- Doherty, T. J., Vandervoort, A. A., & Brown, W. F. (1993). Effects of ageing on the motor unit: a brief review. *Canadian Journal of Applied Physiology, 18*, 331-358.
- Evan, W. J. (1995). What is sarcopenia? *Journal of Gerontology, Series A, 50A*, 5-8.
- Fernie, G. R., Gryfe, C. I., Holliday, P. J., & Llewellyn, A. (1982). The relationship of postural sway in standing to the incidence of falls in geriatric subjects. *Age and Ageing, 11*, 11-16.
- Fitzpatrick, R., & McCloskey, D. I. (1994). Proprioceptive, visual and vestibular threshold for the perception of sway during standing in humans. *Journal of Physiology, 478*, 173-186.
- Fleiss, J. L. (1986). *The design and analysis of clinical experiments*. New York: John Wiley & Sons
- Gauchard, G. C., Jeandel, C., Tessier, A., & Perrin, P. P. (1999). Beneficial effect of proprioceptive physical activities on balance control in elderly human subjects. *Neuroscience Letters, 273*, 81-84.
- Ghelson, G. M., & Whaley, M. H. (1990). Falls in the elderly: Part II, balance, strength, and flexibility. *Archives of Physical Medicine and Rehabilitation, 71*, 439- 41.
- Ghez, C., Gordon, J., & Ghilardi, M. F. (1995). Impairment of reaching movements in patients without proprioception. II. Effects of visual information on accuracy. *Journal of Neurophysiology, 7*, 361-71.
- Ghez, C., & Sainburg, R. (1995). Proprioceptive control of interjoint coordination. *Canadian Journal of Physiology and Pharmacology, 73*, 273-284.
- Gillespie, L. D., Robertson, M. C., Gillespie, W. J., Sherrington, C., Gates, S., Clemson, L. M., & Lamb, S. E. (2012). Interventions for preventing falls in older people living

- in the community (review). *Cochrane Database of Systematic Reviews*, 9, Art No. : CD007146.
- Goble, D. J. (2010). Proprioceptive acuity assessment via joint position matching: From basic science to general practice. *Physical Therapy*, 90, 1176-84.
- Greenspan, A. L., Wolf, S. L. Kelley, M. E., & O'Grady, M. (2007). Tai Chi and perceived health status in older adults who are transitionally frail: A randomized controlled trial. *Physical Therapy*, 87, 525-35.
- Hammond, T., & Wilson, A. (2013). Polypharmacy and falls in the elderly: A literature review. *Nursing and Midwifery Studies*, 1, 171-5.
- Herman, M., Gallagher, E., & Scott, V. (2006). The evolution of senior's falls prevention in British Columbia: BC Ministry of Health Services.
- Hohenadel, J. (2012). Overview of senior's population and falls related hospital utilization. *Northwest Local Health Integration Network*.
- Horlings, C. G., Engelen, G. B., Allum, J. H., & Bloem, B. R. (2008). A weak balance: the contribution of muscle weakness to postural instability and falls. *Nature Clinical Practice Neurology*, 4, 504-515.
- Hong, Y., Li, J. X., & Robinson, P. (2000). Balance control, flexibility, and cardiorespiratory fitness among older tai chi practitioners. *British Journal of Sports Medicine*, 34, 29-34.
- Hovanec, N., Sawant, A., Overend, T. J., Petrella, R. J., & Vandervoort, A. A. (2012). Resistance training and older adults with type 2 diabetes mellitus: strength of evidence. *Journal of Aging Research*, 2012, 1-12.
- Iwamoto, J., Suzuki, H., Tanaka, K., Kumakubu, T., Hirabayashi, H., Miyazaki, Y., &

- Matsumoto, H. (2009). Preventive effects of exercise against falls in the elderly: A randomized controlled trial. *Osteoporosis International, 20*, 1233-40.
- Ivers, R. Q., Cumming, R. G., Mitchell, P., & Attebo, K. (1998). Visual impairment and falls in older adults: The blue mountains eye study. *Journal of American Geriatrics Society, 46*, 58-64.
- Jacobson, B. H., Chen, H. C., Cashel, C., & Guerrero, L. (1997). The effect of Tai Chi Chuan training on balance, kinesthetic sense, and strength. *Perceptual and Motor Skills, 84*, 27-33.
- Jin, P. (1992). Efficacy of Tai-Chi, brisk walking, meditation, and reading in reducing mental and emotional stress. *Journal of Psychosomatic Research, 36*, 361-70.
- Johnson, E. O., & Soucacos, P. N. (2010). Proprioception. *International Encyclopedia of Rehabilitation*.
- Jones, C. J., Rikli, R. E., & Beam, W. C. (1999). A 30-s chair-stand test as a measure of lower body strength in community-residing older adults. *Research Quarterly For Exercise and Sports, 70*, 113-9.
- Kannus, P., Parkkari, J., & Plavanen, M. (2005). Fall-induced deaths among elderly people. *American Journal of Public Health, 95*, 422-424.
- Kaplan, F. S., Nixon, J. E., Reitz, M., Rindfleish, L., & Tucker, J. (1985). Age-related changes in proprioception and sensation of joint position. *Acta Orthopaedica, 56*, 72-74.
- Karlsson, M. K., Magnusson, H., Von Schewelov, T., & Rosengren, B. E. (2013). Prevention of falls in the elderly- a review. *Osteoporosis International, 24*, 747-762.

- Kelley, K. K. (2013). Yoga for prevention of fall. *Journal of Yoga and Physical Therapy*, 3, 133.
- Kepple, T. M., Siegal, K. L., & Stanhope, S. J. (1997). Relative contribution of the lower extremity joint moments to forward progression and support during gait. *Gait and Posture*, 6, 1-8.
- Kirstein, J., & Taylor, J. (2006). The effects of a yoga intervention on the balance, gait and quality of life of people who have multiple sclerosis. *Poster presented at the North American Federation of Adapted Physical Activity*, Ann Arbor, MI.
- Kiran, D., Carlson, M., Medrano, D., & Smith, D. R. (2010). Correlation of three different knee joint position sense measures. *Physical Therapy in Sports*, 11, 81-85.
- Konrad, H. R., Girardi, M., & Helfert, R. (1999). Balance and Aging. *The Laryngoscope*, 109, 1454-1460.
- Kotrlik, J.W., Williams, H.A. (2003). The incorporation of effect size in information technology, learning, and performance research. *Information Technology, Learning, and Performance Journal*, 21, 1-7
- Lajoie, Y., & Gallagher, S. P. (2004). Predicting falls within the elderly community: Comparison of postural sway, reaction time, the Berg balance scale and the Activities-specific Balance Confidence (ABC) scale for comparing fallers and non-fallers. *Archives of Gerontology and Geriatrics*, 38, 11-26.
- Lan, C., Lai, J. S., Chen, S. Y., & Wong, M. K. (2000). Tai Chi Chuan to improve muscular strength and endurance in elderly individuals: A pilot study. *Archives of Physical Medicine and Rehabilitation*, 81, 604-607.
- Lan, C., Lai, J. S., & Chen, S.Y. (2002). Tai Chi Chuan: An ancient wisdom on exercise and

- health promotion. *Sports Medicine*, 32, 217-24.
- Li, F., Harmer, P., Fisher, K. J., McAuley, E., Chaumeton, N., Eckstrom, E., & Wilson, N. L. (2005). Tai Chi and fall reductions in older adults: A randomized controlled trial. *Journal of Gerontology Series A, Biological and Medical Science*, 60, 187-194.
- Li, J. X., Hong, Y., & Chan, K. M. (2001). Tai chi: Physiological characteristics and beneficial effects on health. *British Journal of Sports Medicine*, 35, 148-156.
- Liperoti, R., Landi, F., Russo, A., Giovannini, S., Tosato, M., Capoluongo, E., & Onder, G. (2013). Sarcopenia as a risk factor for falls in elderly individuals: results from the iSIRENTE study. *Clinical Nutrition*, 31, 652-658.
- Liu, J., Wang, Q. X., Zheng, J. J., Pan, J. Y., Hua, H. Y., Zhao, M. S., Shen, Y. L., Fan, S., & Zhong, G. J. (2012). Effects of Tai Chi versus proprioception exercise program on neuromuscular function of ankle in elderly people: A randomized controlled trial. *Evidence Based Complimentary and Alternative Medicine*, 2012, 1-8.
- Lord, S. R., Tiedemann, A., Chapman, K., Munro, B., Murray, S.M., Gerontology, M., Ther, G.R., & Sherrington, C. (2005). The effect of an individualized fall prevention program on fall risk and falls in older people: A randomized, controlled trial. *Journal of American Geriatric Society*, 53, 1296-304.
- Lugade, V., Lin, V., & Chou, L.S. (2011). Center of mass and base of support interaction during gait. *Gait & Posture*, 33(3), 406-411.
- Lu, X., Hui-Chan, C. W., & Tsang, W. W. (2012). Tai Chi, arterial compliance, and muscle strength in older adults. *European Journal of Preventive Cardiology*, 0, 1-7.
- MacIntyre, J., N., Recknor, P., C., & Recknor, C, J. (2014). Spine curve measures taken in individuals with osteoporosis and osteopenia using the IONmed mobile phone application



- are highly consistent with digital inclinometer measures. *ISRN Rehabilitation*, 2014, 1-6.
- Madureira, M. M., Takayama, L., Gallinaro, A. L., Caparbo, V. F., Costa, R. A., & Pereira, R. M. R. (2007). Balance training program is highly effective in improving functional status and reducing the risk of falls in elderly women with osteoporosis: A randomized controlled trial. *Osteoporosis International*, 18, 419-425.
- Mak, M. K., & Ng, P. L. (2003). Mediolateral sway in single-leg stance is the best discriminator of balance performance for Tai-Chi practitioners. *Archives of Physical Medicine and Rehabilitation*, 84, 683-6.
- Mion, L. C., Gregor, S., Buethner, M., Chwirchak, D., Lee, O., & Paras, W. (1989). Falls in the rehabilitation settings: Incidences and characteristics. *Rehabilitation Nursing*, 14, 17-22.
- Moreland, J. D., Richardson, J. A., Goldsmith, C. H., & Clase, C. M. (2004). Muscle weakness and falls in older adults: A systematic review and meta-analysis. *Journal of American Geriatric Society*, 52, 1121-1129.
- Naito, E., Nakashima, T., Kito, T., Aramaki, Y., Okada, T., & Sadato, N. (2007). Human limb-specific and non-limb specific brain representation during kinesthetic illusory movements of the upper and lower extremities. *European Journal of Neuroscience*, 25, 3476-87.
- Nevitt, M. C., Cummings, S. R., & Hudes, E. S. (1991). Risk factors for injurious falls: A prospective study. *Journal of Gerontology*, 46, M 164-170.
- O'Loughlin, J. L., Robitaille, Y., Boivin, J. f., & Sulssa, S. (1993). Incidence of and risk factors for falls and injurious falls among community dwelling elderly. *American Journal of Epidemiology*, 137, 342-354.

- Park, S., Shoemaker, C., & Haub, M. (2008). Can older gardeners meet the physical activity recommendation through gardening? *HortTechnology*, *18*, 639-643.
- Petrella, R. J., Lattanzio, P. J., & Nelson, M.G. (1997). Effects of age and activity on knee joint proprioception. *American Journal of Physical Medicine & Rehabilitation*, *76*, 235-241.
- Podsiadlo, D., & Richardson, S. (1991). The timed "Up & Go": A test of basic functional mobility for frail elderly persons. *Journal of American Geriatric Society*, *39*, 142-8.
- Porske, U. (1997). The mammalian muscle spindle. *Physiology*, *12*, 37-42.
- Public Health Agency of Canada. (2005). *Inventory of fall prevention initiatives in Canada 2005*. Ottawa: Division of Aging and Seniors, Public Health Agency of Canada
- Ribeiro, F., & Oliveira, J. (2007). Aging effects on joint proprioception: The role of physical activity in proprioception preservation. *European Review of Aging and Physical Activity*, *4*, 71-76.
- Robinovitch, N. S., Feldman, F., Yang, Y., Schonnop, R., Luen, M. P., Sarraf, T., Gould-Sims, J., & Loughin, M. (2013). Video capture of the circumstances of falls in elderly people residing in long-term care: An observational study. *Lancet*, *381*, 47-54.
- Sachs, G. M. (2008). Peripheral neurology: Special concerns in elderly. *Medicine and Health*, *91*, 142-143.
- Sattin, R. W., Easley, K. A., Wolf, S. L., Chen, Y., & Kutner, M. H. (2005). Reduction in fear of falling through intense tai chi exercise training in older, transitionally frail adults. *Journal of American Geriatric Society*, *53*, 1168-78.
- Salva, A., Bolibar, I., Pera, G., & Arias, C. (2004). Incidence and consequence of falls among elderly people living in the community. *Medicina Clinica*, *122*, 172-176.

- Scheffer, A. C., Schuurmans, M. J., Dijk, N. V., Hooft, T. V., & Rooij, S. E. (2008). Fear of falling: Measurement strategy, prevalence, risk factors and consequences among older persons. *Age and Ageing, 31*, 19-24.
- Schmid, A. A., Puymbroeck, M. V., & Kocejka, D. M. (2010). Effects of 12-week yoga intervention on fear of falling and balance in older adults: A pilot study. *Archives of Physical Medicine and Rehabilitation, 91*, 576-83.
- Scott, V.J. (2005). Technical report: Hospitalizations due to falls among Canadians age 65 and over. *In Report on Seniors' falls in Canada. Canada, Minister of Public Works and Government Services.*
- Scott, V., Wager, L., & Elliot, S. (2010). Falls and related injuries among older Canadians: Fall-related hospitalization and intervention initiatives. *Prepared on behalf of the Public Health Agency of Canada, Division of Aging and Seniors.* Victoria BC: Victoria Scott Consulting.
- Scuffham, P., Chaplin, S., & Legood, R. (2003). Incidence and costs of unintentional falls in older people in the United Kingdom. *Journal of Epidemiology and Community Health, 57*, 740-744.
- Sharma, L., Pai, Y. C., Holtkamp, K., & Rymer, Z. (1997). Is knee joint proprioception worse in arthritic knee versus the unaffected knee in unilateral knee osteoarthritis. *Arthritis & Rheumatism, 40*, 1518-25.
- Sherrington, C.S. (1906). The integrative action of the nervous system. *Yale University Press.* New Haven.
- Shumway-Cook, A., Brauer, S., & Woolacott, M. (2000). Predicting the probability for falls in community-dwelling older adults using the Timed Up & Go test. *Physical Therapy, 80*,

896-903.

Silsupadol, P., Siu, K. C., Shumway-Cook, A., & Woollacott, M. H. (2006). Training of balance under single and dual-task conditions in older adults with balance impairment. *Physical Therapy, 86*, 269-281.

Spaniolas, K., Cheng, J. D., Gestring, M. L., Sangosanya, A., Stassen, N. A., & Bankey, P.E. (2010). Ground level falls are associated with significant mortality in elderly patients. *Journal of Trauma, 69*, 821-825.

Steffen, T. M., Hacker, T. A., & Mollinger, L. (2002). Age- and gender-related test performance in community-dwelling elderly people: Six minute walk test, berg balance scale, timed up & go test, and gait speeds. *Physical Therapy, 82*, 128-137.

Stel, V. S., Smit, J. H., Pluijm, S.M., & Lips, P. (2004). Consequences of falling in older men and women and risk factors for health service use and functional decline. *Age and Ageing, 33*, 58-65.

Stelmach, G.E., & Sirica, A. (1986). Aging and proprioception. *Age, 9*, 99-103.

Stevans, J. A., Corso, P. S., Finkelstein, E. A., & Miller, T. R. (2006). The cost of fatal and non-fatal falls among older adults. *Injury Prevention, 12*, 290-295.

Sturnieks, D. L., George, R. S., & Lord, S. R. (2008). Balance disorders in the elderly. *Clinical Neurophysiology, 38*, 467-478.

Taylor-Piliae, R. E., Silva, E., & Sheremeta, S. P. (2012). Tai Chi as an adjunct physical activity for adults aged 45 years and older enrolled in phase III cardiac rehabilitation. *European Journal of Cardiovascular Nursing, 11*, 34-43.

Talbot, L. A., Musiol, R. J., Witham, E. K., & Metter, E. J. (2005). Falls in young, middle-aged and older community dwelling adults: Perceived cause, environmental factors and injury.

*BMC Public Health*, 5

- Thapa, P. B., Brockman, K. G., Gideon, P., Fought, R. L., & Ray, W.A. (1996). Injurious falls in non ambulatory nursing home residents: a comparative study of circumstances, incidence, and risk factors. *Journal of American Geriatric Society*, 44, 273-278.
- Tiedemann, A., O'Rourke, S., Sesto, R., & Sherrington, C. (2013). A 12-week Iyengar yoga program improved balance and mobility in older community-dwelling people: A pilot randomized controlled trial. *Journal of Gerontology: Series A*, 68, 1068-75.
- Tinetti, M. E., Speechley, M., & Ginter, S. F. (1988). Risk factors for falls among elderly persons living in the community. *New England Journal of Medicine*, 319, 1701-1707.
- Todd, C., & Skelton, D. (2004). What are the main risk factors for falls amongst older people and what are the most effective interventions to prevent these falls? Copenhagen, WHO Regional Office for Europe (Health evidence network report).
- Tomlinson, B. E., & Irving, D. (1977). The number of limb motor neuron in the human lumbosacral cord throughout life. *Journal of Neurological Sciences*, 34, 213-9.
- Tsang, W. W., & Hui-Chan, C.W. (2003). Effects of tai chi on joint proprioception and stability limits in elderly subjects. *Medicine and Science in Sports and Exercise*, 35, 1962-71.
- Tsang, W.W., & Hui-Chan, C.W. (2003). Effects of exercise on joint sense and balance in elderly men: Tai Chi versus golf. *Medicine and Science in Sports and Exercise*, 36, 658-67.
- Tunnainen, E., Rasku, J., Jantti, P., & Pyykko, I. (2013). Risk factors of falls in community dwelling active elderly. *Auris Nasus Larynx*, 41, 10-16.
- Vandervoot, A. A., Kramer, J.F., & Wharram, E. R. (1989) Eccentric knee strength of elderly

- females. *Journal of Gerontology*, 45, B125-B128.
- VanSwearingen, J.M., & Brach, J.S. (2001). Making geriatric assessment work: Selecting useful measures. *Physical Therapy*, 81, 1233- 1252.
- Verdijk, L. B., Snijders, T., Beelen, M., Savelberg, H., Meijer, K., Kuipers, H., & Loon, L. (2010). Characteristics of muscle fiber type are predictive of skeletal muscle mass and strength in elderly men. *Journal of American Geriatrics Society*, 58, 2069-75.
- Visser, M., Kritchevsky, S. B., Goodpaster, B. H., Newman, A. B., Nevitt, M., Stamm, E., & Harris, T.B. (2002). Leg muscle mass and composition in relation to lower extremity performance in men and women aged 70-79: The health, aging, and body composition study. *Journal of American Geriatric Society*, 50, 897-904.
- Wall, J. C., Bell, C., Campbell, S., & Davis, J. (2000). The Timed Get-up-and-Go test revisited: Measurement of the component tasks. *Journal of Rehabilitation Research and Development*, 37, 109-114.
- Weiner, D. K., Hanlon, J. T., & Studenski, S. A. (1998). Effects of central nervous system polypharmacy on falls liability in community dwelling elderly. *Gerontology*, 44, 217-221.
- Whipple, R. H., Wolfson, L. I., & Amerman, P. M. (1987). The relationship of knee and ankle weakness to falls in nursing home residents: An isokinetic study. *Journal of American Geriatric Society*, 35, 13- 20.
- Winter, D.A. (1995). Human balance and posture control during standing and walking. *Gait & Posture*, 3, 193-214.
- Wolfson, L., Judge, J., Whipple, R., & King, M. (1995). Strength is a major factor in balance, gait, and the occurrence of falls. *Journal of Gerontology*, 50A, 64-67.

- Wolf, S. L., Barnhart, H. X., Ellison, G. L., Coogler, C. E., & Atlanta FICSIT. (1997). The effect of Tai Chi Quan and computerized balance training on postural stability in older subjects. *Physical Therapy, 77*, 371-381.
- Woolf, A. D., & Akesson, K. (2003). Preventing fractures in elderly people. *British Medical Journal, 327*, 89-95.
- Woollacott, M. H., Shumway- Cook, A., & Nashner, L. M. (1986). Aging and postural control: Changes in sensory organization and muscular coordination. *The international Journal of Aging and Human Development, 23*, 97-114.
- Wu, G., Zhao, F., Zhou, X., & Wei, L. (2002). Improvement of isokinetic knee extensor strength and reduction of postural sway in the elderly from long-term Tai Chi exercise. *Archives of Physical Medicine and Rehabilitation, 83*, 1364-1369.
- Xian, J., Qing, D., & Hong, Y. (2008). Effects of 16-week Tai Chi intervention on postural stability and proprioception of knee and ankle in older people. *Age and Ageing, 37*, 575-578.
- Xu, D., Hong, Y., & Li, J., Chan, K. (2004). Effect of tai chi exercise on proprioception of ankle and knee joints in old people. *British Journal of Sports Medicine, 38*, 50-54.
- Yang, Y. (2008). The effects of a Taiji Quan exercise intervention on balance, mobility, and quality of life of people treated for cancer. Unpublished master's thesis, Lakehead University, Thunder Bay, ON.
- Zettergren, K.K., Moriarty, E., & Zabel, A. (2005). The effectiveness of therapeutic yoga on community dwelling older adults with and without balance deficits. *Journal of Neurologic Physical Therapy, 29(4)*, 216.

## Appendix A

### Pilot Study Consent Form

#### **Strategies to prevent falls in the elderly: Effect of 10-week Taiji training program on ankle proprioception, functional mobility and lower extremity strength in older adults who are at risk for falls**

My name is Anshul Jain, a graduate student in the School of Kinesiology. I am conducting a test of the functionality of my equipment for use in measuring ankle proprioception in a study of a Taiji intervention with older adults. If you consent to assist me in this study I am asking you to stand on a platform which will move either forward or back while you are blind folded and wearing headphones with white sound. You will indicate when you detect movement of the surface. The method will include a demonstration trial, four practice trials, and four test trials. The entire process will take 5-10 minutes. This study has received approval from the Lakehead University Research Ethics Board.

The procedure involves no more risk than a simple standing activity that you might do in your home. You are a volunteer and can withdraw from this study at any time without consequence. The data gathered will be kept confidential and will be used solely for the purpose of determining the accuracy and efficiency of the equipment and test protocol. By taking part in this study you will help me in completing my graduate research.

I have read the above and understand what is required of me and have had a chance to ask questions before I consent to the study. I acknowledge the following terms:

1. I am volunteering to participate for the ankle proprioception assessment and can withdraw from the study at any time.
2. There is no more risk of physical or psychological harm than would be involved in



physical activities performed in my home.

3. All information that I provide will be confidential.
4. The data gathered will be used to assess the accuracy of the proprioception equipment and will not be used for any other purpose.
5. By signing below, I acknowledge that I understand the risk and benefits of this assessment protocol and I consent to participate.

Name \_\_\_\_\_

Age \_\_\_\_\_

Date \_\_\_\_\_

Signature \_\_\_\_\_

Anshul Jain  
(647) 886-3365

Dr. Jane Taylor  
(807) 251- 3680

Appendix B  
Proprioception Testing Device

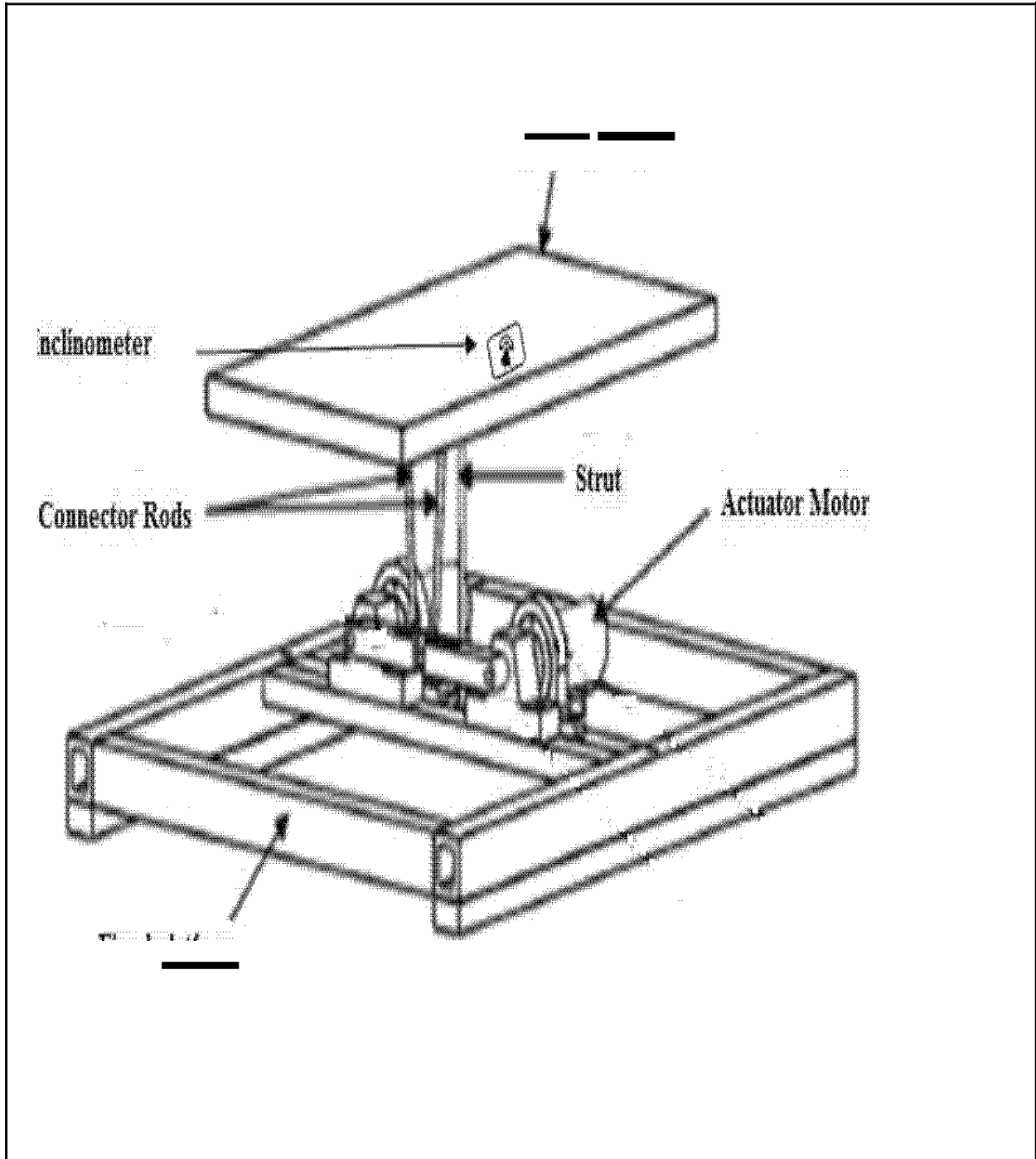

## Yin and Yang: Taiji and Falls Prevention

A study on falls prevention in older adults

- **What is the study about?**  
To determine the effects of Taiji on ankle joint movement sense, balance, and mobility in older adults who are at risk for falls.
- **Who is eligible to participate?**  
Older adults (aged 65 +) with problems in mobility and balance who:
  - Have experienced a fall within the last 12 months
  - Are able to stand unassisted
  - Can walk freely or with the assistance of a walker or cane
- **What will be required of you?**
  1. Attend initial and final assessment of proprioception, balance, and mobility.
  2. Attend a twice weekly 10 week Taiji class.
- **Where does the study take place?**  
The study sessions and Taiji classes will be conducted at the multi-purpose laboratory in the C.J. Sanders Field House, School of Kinesiology at Lakehead University and Peng You Taiji Quan Association.

**For more information please contact:**

Anshul Jain  
ajain@lakeheadu.ca  
(647)- 886-3365

Dr. Jane Taylor  
jtaylor@lakeheadu.ca  
(807)-251-3680  
School of Kinesiology  
Lakehead University

**This study has been approved by the Lakehead University Research Ethics Board. If you have any questions related to the ethics of the research and would like to speak to someone outside of the research team please contact Sue Wright at the Research Ethics Board at 807-343-8283 or research@lakeheadu.ca**

## Appendix D

### Main Study Consent Form

#### **Strategies to prevent falls in the elderly: Effect of 10-week Taiji training program on ankle proprioception, functional mobility and lower extremity strength in older adults who are at risk for falls**

I have read and understand the following information:

1. I am volunteering to participate in this program and can withdraw from the study at any time.
2. I agree to be assigned to either an intervention or control group.
3. I will attend as many exercise sessions as possible during the intervention.
4. I may stop exercising at any time if I have any difficulties.
5. There is no more risk of physical or psychological harm than would be involved in physical activities performed in my home.
6. I will be assessed by Anshul Jain on my ankle joint position and movement sense, functional mobility, balance and lower extremity strength.
7. I will record the length of time that I practice Taiji Qigong and other physical activities at home in a logbook provided by the researcher.
8. Transportation will be provided for me to and from the University, if needed.
9. All information that I provide will be confidential and will be stored with Dr. Jane Taylor for five years in the School of Kinesiology, Lakehead University.
10. I understand that my identity will be kept anonymous in any reporting, presentation, or publication of the results.
11. I will receive a summary of the project if I check off the box underneath my signature on

this page, or if I request it during the length of the study.

12. I will receive a signed and dated copy of this consent form.

13. By signing below, I acknowledge that I understand the risk and benefits of this study and I consent to participate.

\_\_\_\_\_

Signature of participant

\_\_\_\_\_

Date

\_\_\_\_\_

Phone number of participant

I wish to receive a summary of the results of this study following completion of this study

Anshul Jain  
(647) 886-3365

Dr. Jane Taylor  
(807) 251- 3680

## **Appendix E Cover Letter**

### **Strategies to prevent falls in the elderly: Effect of a 10-week Taiji training program on ankle proprioception, functional mobility, and lower extremity strength in older adults who are at risk for falls.**

Dear Potential Participant,

My name is Anshul Jain, a master's student studying the effects of Taiji Qigong on proprioception (sense of joint position and joint movement), functional mobility, and lower extremity strength in older adults under the supervision of Dr. Jane Taylor in the School of Kinesiology at Lakehead University. Many older adults experience falls as they age. There is plenty of research which describes the declining functional mobility and physical performance in older adults. Lack of physical activity is a major contributing factor along with non-adherence to typical exercise programs. Taiji Qigong is a form of body-mind exercise that improves physical (e.g., muscle strength, balance, and mobility), psychological (depression, anxiety, and stress), and psychosocial functions in older adults. This program may potentially reduce falls by improving your sense of ankle position and movement (proprioception).

If you experienced any fall in the last 12-months and are having balance and mobility problems, you are eligible to participate in this study. The study will involve an initial assessment session, 10-weeks of Taiji training or waitlist for Taiji (control group), and final assessment session.

The evaluation will be conducted at the School of Kinesiology in the C.J. Sanders Field House at Lakehead University. Participation in the assessment will introduce no more risk than is imposed by physical exercise at home. To keep risk for falls during assessment to a minimum

during functional mobility and proprioception tests, a catcher will be present. The assessment procedure comprises completing forms about demographic information, health status, PAR Q+ and performing tests of ankle joint position and movement sense (proprioception), functional mobility which includes balance, and lower extremity strength that will take one hour of your time. In these tests you will be asked to: stand and tell us when you feel your ankle moving; stand in one spot and gently lean forward and back; walk 3-meters and return; and stand up from a sitting position as many times as you can in 30-seconds.

After completing the initial assessment you will be randomly assigned to either the intervention, or the control group. The intervention group will participate in a 10-week Taiji Qigong program. The training will be provided in the Sanders Field House at Lakehead University, two times per week, over a one hour session. The Taiji Qigong sessions will be conducted by a trained instructor from the Peng You Taiji Quan Association in Thunder Bay, Ontario.

To improve your balance, proprioception and prevent the incidence of falls we strongly encourage you to attend as many training sessions as possible. However, participation in this study is completely voluntary, you may withdraw from the study at anytime, and you may refuse to participate at any time. If you have any discomfort or difficulty practicing the exercise, you can rest at any time.

It is our hope that this study will help in preventing falls and in enduring an active life. We will provide you with a DVD of Taiji Qigong so you may practice at home if you wish. A log will be provided to record all physical activities including Taiji. If you are in the control group you will be encouraged to refrain from Taiji Quan exercises and record your involvement

in any physical activity during the 10-week period. Each participant in the control group will be offered a chance to participate in the Taiji program at the end of the intervention. Please be advised that transportation will be provided for you to and from the Field house, if you require it.

After the 10-week Taiji training, your proprioception, mobility, and balance and strength will be measured again as in the initial assessment. You will also be requested to complete a short questionnaire about your experience in the program. You may refuse to answer any questions that you are not comfortable answering.

Your identity will be kept confidential and there is no identified risk from participating in this study. Your name will not appear in any reporting of results as the information you provide will be coded. All information and data will be securely stored at Lakehead University's School of Kinesiology laboratory for five years with Dr. Jane Taylor. The results of this study may be presented at a conference and published in the conference proceedings for widespread distribution to the academic community.

Results of this study will be made available to you at your request upon completion of the project. Further information regarding the research can be obtained from Anshul Jain at (647) 886-3365, or Dr. Jane Taylor at (807) 251-3680. This study has been approved by the Lakehead University Research Ethics Board. If you have any questions related to the ethics of the research and would like to speak to someone outside of the research team please contact Sue Wright at the Research Ethics Board at 807-343-8283 or [research@lakeheadu.ca](mailto:research@lakeheadu.ca).

Thank you for your consideration. Your help is greatly appreciated.

Sincerely  
Jane Taylor, PhD  
[jtaylor@lakeheadu.ca](mailto:jtaylor@lakeheadu.ca)

Anshul Jain  
[ajain@lakeheadu.ca](mailto:ajain@lakeheadu.ca)



**Appendix F**  
**Participant Demographic and Fall History Information**

<b>Personal information</b>	
Name : (Last, First, Middle)	
Gender: <input type="checkbox"/> Male <input type="checkbox"/> Female	Date of birth:
Dominant hand:	Height:
Address:	
City and Postal code:	
Home phone:	Cell:
Email:	
Emergency contact person:	Phone:

**Falls History**

1. How many falls you had in past 12 months? \_\_\_\_\_

**Please provide details on the most recent fall**

Fall #1	
Where did you fall?	
What were you doing?	
Why did you fall?	
What time of the day did you fall?	(Morning, afternoon, evening, night) <input type="radio"/> <input type="radio"/> <input type="radio"/> <input type="radio"/>
Type of footwear	
Injury      Yes / No <input type="radio"/> <input type="radio"/>	If yes, provide details:

## Appendix G

### PAR-Q+ Questionnaire

CSEP approved Sept 12 2011 version

# PAR-Q+

## The Physical Activity Readiness Questionnaire for Everyone

Regular physical activity is fun and healthy, and more people should become more physically active everyday of the week. Being more physically active is very safe for MOST people. This questionnaire will tell you whether it is necessary for you to seek further advice from your doctor OR a qualified exercise professional before becoming more physically active.

### SECTION 1 - GENERAL HEALTH

Please read the 7 questions below carefully and answer each one honestly: check YES or NO.		YES	NO
1.	Has your doctor ever said that you have a heart condition OR high blood pressure?	<input type="radio"/>	<input type="radio"/>
2.	Do you feel pain in your chest at rest, during your daily activities of living, OR when you do physical activity?	<input type="radio"/>	<input type="radio"/>
3.	Do you lose balance because of dizziness OR have you lost consciousness in the last 12 months? Please answer NO if your dizziness was associated with over-breathing (inducting during vigorous exercise).	<input type="radio"/>	<input type="radio"/>
4.	Have you ever been diagnosed with another chronic medical condition (other than heart disease or high blood pressure)?	<input type="radio"/>	<input type="radio"/>
5.	Are you currently taking prescribed medications for a chronic medical condition?	<input type="radio"/>	<input type="radio"/>
6.	Do you have a bone or joint problem that could be made worse by becoming more physically active? Please answer NO if you had a joint problem in the past, but it does not limit your current ability to be physically active. For example, knee, ankle, shoulder or other.	<input type="radio"/>	<input type="radio"/>
7.	Has your doctor ever said that you should only be medically supervised physical activity?	<input type="radio"/>	<input type="radio"/>

If you answered NO to all of the questions above, you are cleared for physical activity.

Go to Section 3 to sign the form. You do not need to complete Section 2.

- Start becoming much more physically active - start slowly and build up gradually.
- Follow the Canadian Physical Activity Guidelines for your age (visit [www.csep.ca/guidelines](http://www.csep.ca/guidelines)).
- You may take part in a health and fitness appraisal.
- If you have any further questions, contact a Qualified exercise professional such as a CSEP Certified Exercise Physiologist (CSEP-CEP) or CSEP Certified Personal Trainer (CSEP-CPT).
- If you are over the age of 45 yrs. and NOT accustomed to regular vigorous physical activity, please consult a Qualified exercise professional (CSEP-CEP) before engaging in maximal effort exercise.



If you answered YES to one or more of the questions above, please GO TO SECTION 2.



Delay becoming more active if:

- You are not feeling well because of a temporary illness such as a cold or fever - wait until you feel better.
- You are pregnant - talk to your health care practitioner, your physician, a qualified exercise professional, and/or complete the PARmed-X for Pregnancy before becoming more physically active OR
- Your health changes - please answer the questions on Section 2 of this document and/or talk to your doctor or Qualified exercise professional (CSEP-CEP or CSEP-CPT) before continuing with any physical activity programme.



**SECTION 2 - CHRONIC MEDICAL CONDITIONS**

Please read the questions below carefully and answer each one honestly - check YES or NO.		YES	NO
1.	Do you have Arthritis, Osteoporosis, or Back Problems?	<input type="radio"/> YES If yes, answer questions 1a-1c	<input type="radio"/> NO If no, go to question 2
1a.	Do you have difficulty controlling your condition with medications or other physician-prescribed therapies? (Answer NO if you are not currently taking medications or other treatments)	<input type="radio"/>	<input type="radio"/>
1b.	Do you have joint problems causing pain, a recent fracture or fracture caused by osteoporosis or cancer, displaced vertebra (e.g., spondylolisthesis), and/or spondylolysis/pars defect (a crack in the bony ring on the back of the spinal column)?	<input type="radio"/>	<input type="radio"/>
1c.	Have you had steroid injections or taken steroid tablets regularly for more than 3 months?	<input type="radio"/>	<input type="radio"/>
2.	Do you have Cancer of any kind?	<input type="radio"/> YES If yes, answer questions 2a-2b	<input type="radio"/> NO If no, go to question 3
2a.	Does your cancer diagnosis include any of the following types: lung/bronchogenic, multiple myeloma (cancer of plasma cells), head, and neck?	<input type="radio"/>	<input type="radio"/>
2b.	Are you currently receiving cancer therapy (such as chemotherapy or radiotherapy)?	<input type="radio"/>	<input type="radio"/>
3.	Do you have Heart Disease or Cardiovascular Disease? This includes Coronary Artery Disease, High Blood Pressure, Heart Failure, Diagnosed Abnormality of Heart Rhythm	<input type="radio"/> YES If yes, answer questions 3a-3e	<input type="radio"/> NO If no, go to question 4
3a.	Do you have difficulty controlling your condition with medications or other physician-prescribed therapies? (Answer NO if you are not currently taking medications or other treatments)	<input type="radio"/>	<input type="radio"/>
3b.	Do you have an irregular heart beat that requires medical management? (e.g. atrial fibrillation, premature ventricular contraction)	<input type="radio"/>	<input type="radio"/>
3c.	Do you have chronic heart failure?	<input type="radio"/>	<input type="radio"/>
3d.	Do you have a resting blood pressure equal to or greater than 160/90 mmHg with or without medication? (Answer YES if you do not know your resting blood pressure)	<input type="radio"/>	<input type="radio"/>
3e.	Do you have diagnosed coronary artery (cardiovascular) disease and have not participated in regular physical activity in the last 2 months?	<input type="radio"/>	<input type="radio"/>
4.	Do you have any Metabolic Conditions? This includes Type 1 Diabetes, Type 2 Diabetes, Pre-Diabetes	<input type="radio"/> YES If yes, answer questions 4a-4c	<input type="radio"/> NO If no, go to question 5
4a.	Is your blood sugar often above 12.0 mmol/L? (Answer YES if you are not sure)	<input type="radio"/>	<input type="radio"/>
4b.	Do you have any signs or symptoms of diabetes complications such as heart or vascular disease and/or complications affecting your eyes, kidneys, and the sensation in your toes and feet?	<input type="radio"/>	<input type="radio"/>
4c.	Do you have other metabolic conditions (such as thyroid disorders, pregnancy-related diabetes, chronic kidney disease, liver problems)?	<input type="radio"/>	<input type="radio"/>
5.	Do you have any Mental Health Problems or Learning Difficulties? This includes Alzheimer's, Dementia, Depression, Anxiety Disorder, Eating Disorder, Psychotic Disorder, Intellectual Disability, Dementia Syndrome	<input type="radio"/> YES If yes, answer questions 5a-5b	<input type="radio"/> NO If no, go to question 6
5a.	Do you have difficulty controlling your condition with medications or other physician-prescribed therapies? (Answer NO if you are not currently taking medications or other treatments)	<input type="radio"/>	<input type="radio"/>
5b.	Do you also have back problems affecting nerves or muscles?	<input type="radio"/>	<input type="radio"/>



Please read the questions below carefully and answer each one honestly - check YES or NO.		YES	NO
b	Do you have a Respiratory Disease? This includes Chronic Obstructive Pulmonary Disease, Asthma, Pulmonary High Blood Pressure	<input type="radio"/> YES If yes, answer questions 6a-6d	<input type="radio"/> NO If no, go to question 7
	6a. Do you have difficulty controlling your condition with medications or other physician-prescribed therapies? (Answer NO if you are not currently taking medications or other treatments)	<input type="radio"/>	<input type="radio"/>
	6b. Has your doctor ever said your blood oxygen level is low at rest or during exercise and/or that you require supplemental oxygen therapy?	<input type="radio"/>	<input type="radio"/>
	6c. If you have asthma, do you currently have any symptoms of chest tightness, wheezing, labored breathing, consistent cough (more than 2 days/week), or have you used your rescue medication more than 2 times in the last week?	<input type="radio"/>	<input type="radio"/>
	6d. Has your doctor ever said you have high blood pressure in the blood vessels of your lungs?	<input type="radio"/>	<input type="radio"/>
7.	Do you have a Spinal Cord Injury? This includes Tetraplegia and Paraplegia	<input type="radio"/> YES If yes, answer questions 7a-7c	<input type="radio"/> NO If no, go to question 8
	7a. Do you have difficulty controlling your condition with medications or other physician-prescribed therapies? (Answer NO if you are not currently taking medications or other treatments)	<input type="radio"/>	<input type="radio"/>
	7b. Do you commonly exhibit low resting blood pressure significant enough to cause dizziness, lightheadedness, and/or fainting?	<input type="radio"/>	<input type="radio"/>
	7c. Has your physician indicated that you exhibit sudden bouts of high blood pressure (known as Autonomic Dysreflexia)?	<input type="radio"/>	<input type="radio"/>
9.	Have you had a Stroke? This includes Transient Ischemic Attack (TIA) or Cerebrovascular Event	<input type="radio"/> YES If yes, answer questions 8a-c	<input type="radio"/> NO If no, go to question 9
	8a. Do you have difficulty controlling your condition with medications or other physician-prescribed therapies? (Answer NO if you are not currently taking medications or other treatments)	<input type="radio"/>	<input type="radio"/>
	8b. Do you have any impairment in walking or mobility?	<input type="radio"/>	<input type="radio"/>
	8c. Have you experienced a stroke or impairment in nerves or muscles in the past 6 months?	<input type="radio"/>	<input type="radio"/>
9.	Do you have any other medical condition not listed above or do you live with any chronic conditions?	<input type="radio"/> YES If yes, answer questions 9a-c	<input type="radio"/> NO If no, read the advice on page 4
	9a. Have you experienced a blackout, fainted, or lost consciousness as a result of a head injury within the last 12 months OR have you had a diagnosed concussion within the last 12 months?	<input type="radio"/>	<input type="radio"/>
	9b. Do you have a medical condition that is not listed (such as epilepsy, neurological conditions, kidney problems)?	<input type="radio"/>	<input type="radio"/>
	9c. Do you currently live with any chronic conditions?	<input type="radio"/>	<input type="radio"/>

Please proceed to Page 4 for recommendations for your current medical condition and sign this document.



# PAR-0+

If you answered NO to all of the follow-up questions about your medical condition, you are ready to become more physically active:

- ) It is advised that you consult a qualified exercise professional (e.g., a CSEP-CEP or CSEP-CPT) to help you develop a safe and effective physical activity plan to meet your health needs.
- ) You are encouraged to start slowly and build up gradually – 20-60 min. of low- to moderate-intensity exercise, 3-5 days per week including aerobic and muscle strengthening exercises.
- ) As you progress, you should aim to accumulate 150 minutes or more of moderate-intensity physical activity per week.
- ) If you are over the age of 45 yrs. and NOT accustomed to regular vigorous physical activity, please consult a qualified exercise professional (CSEP-CEP) before engaging in maximal effort exercise.



If you answered YES to one or more of the follow-up questions about your medical condition:

- ) You should seek further information from a licensed health care professional before becoming more physically active or engaging in a fitness appraisal and/or visit a or qualified exercise professional (CSEP-CEP) for further information.



Delay becoming more active if:

- ) You are not feeling well because of a temporary illness such as a cold or fever – wait until you feel better
- ) You are pregnant – talk to your healthcare practitioner, your physician, a qualified exercise professional, and/or complete the PARmed-X for Pregnancy before becoming more physically active OR
- ) Your health changes – please talk to your doctor or qualified exercise professional (CSEP-CEP) before continuing with any physical activity programme.

## SECTION 3 - DECLARATION

- ) You are encouraged to photocopy the PAR-Q+. You must use the entire questionnaire and NO changes are permitted.
- ) The Canadian Society for Exercise Physiology, the PAR-Q+ Collaboration, and their agents assume no liability for persons who undertake physical activity. If in doubt after completing the questionnaire, consult your doctor prior to physical activity.
- ) If you are less than the legal age required for consent or require the assent of a care provider, your parent, guardian or care provider must also sign this form.
- ) Please read and sign the declaration below:

*I, the undersigned, have read, understood to my full satisfaction and completed this questionnaire. I acknowledge that this physical activity clearance is valid for a maximum of 12 months from the date it is completed and becomes invalid if my condition changes. I also acknowledge that a Trustee (such as my employer, community/fitness centre, health care provider, or other designate) may retain a copy of this form for their records. In these instances, the Trustee will be required to adhere to local, national, and international guidelines regarding the storage of personal health information ensuring that they maintain the privacy of the information and do not misuse or wrongfully disclose such information.*

NAME \_\_\_\_\_ DATE \_\_\_\_\_

SIGNATURE \_\_\_\_\_ WITNESS \_\_\_\_\_

SIGNATURE OF PARENT/GUARDIAN/CARE PROVIDER \_\_\_\_\_

For more information, please contact:  
Canadian Society for Exercise Physiology  
www.csep.ca

### KEY INFORMANTS

1. J. L. ... W. ... R. M. B. ... J. M. ... w. DC, ... R. L. ... J. ... N. E. ... g. ... h. ... t. ... n. ... l. ... f. ... y. ... t. ... i. ... t. ... p. ... t. ... l. ... l. ... b. ... g. ... o. ... u. ... n. ... d. ... o. ... o. ... t. ... l. ... p. ... r. ... o. ... c. ... : ... A. P. N. M. 3. Q. S. I. E. S. S. I. ; o. n.
2. ... R. ... N. ... J. ... V. ... Brodin SSD, McKon/SoOC, StonoJ, Ch LaworS, and Sh ... d. R. J. E. V. I. d. b. ; ; G. d. l. l. : u. u. m. I. and G. C. o. m. m. o. n. d. O. n. J. o. t. F. h. l. l. a. t. ; c. l. H. t. C. k. l. a. t. n. e. : : C. o. n. J. u. O. o. m. I. A. P. N. M. j. e. f. S. I. : 526647; 9, 1 1.

TM PAR-Q+ was created USING the e-idee- b; n; d AGE process (1) by TM PAR-Q+ Collaboration chaired by Dr. Darren E. R. Warburton With Or. Hetman Gledhill, Dr. Veronca Jamnik, and Dr. Donald C. M. Kenzie (2). Product of this document has been made possible through financial contributions from the Public Health Agency of Canada and the 8C Ministry of Health Services. TM/wme: q. e. s. s. : M. f. i. n. do not necessarily represent the views of the Public Health Agency of Canada or 8C Ministry of Health Services.



COPYRIGHT © 2012 4/4  
CSEP approved Sept 12 2011 ve4'Sion

## Appendix H

### Social Validation Questionnaire

Please read the following questions and provide the response which best explains your opinion about the exercise program. Your honest opinions, positive or negative, are greatly appreciated.

**1. How do you feel that your life has changed since you have been in the Taiji program?**

<b>1</b>	<b>2</b>	<b>3</b>	<b>4</b>	<b>5</b>
Much worse	A bit worse	Nothing changed	A bit better	A great deal

Please explain why you feel that way?

**2. Did you change any other daily activity or exercise habits during the Taiji sessions?**

Yes No

Please explain what type of daily exercise or activity has been changed?

**3. Did you have any treatment or medication change during the Taiji sessions?**

Yes No

Please indicate what treatment or medication was changed?

**4. If this Taiji program will be offered again, would you choose to participate?**

Yes No

Please explain why you feel that way?

**5. Would you recommend this program to a friend?**

Yes No Undecided

Please explain why you feel that way?

**6. Do you feel that your instruction was geared towards your ability level?**

Yes

No

Undecided

Please explain why you feel this way?

**7. How did you feel about the length of the program and the exercise session?**

1

2

3

Too long

Just right

Too short

Please explain why you feel that way?

**8. In general were you satisfied with this program?**

Yes

No

Undecided

Please explain why you feel this way?

**9. Do you have any other comments about your participation in the Taiji program?**

## Appendix I

### ATGUG Test

**Purpose:** To test functional balance and mobility

**Equipment:**

- Chair with a straight back without arm rests (seat 17” high).
- A stopwatch

**Directions:** Participants wear their regular footwear and can use a walking aid, if needed. Begin by having the participant sit back in a standard chair and identify a line 3 meters on the floor.

**Instructions to the participant:**

When I say “Go, “I want you to:

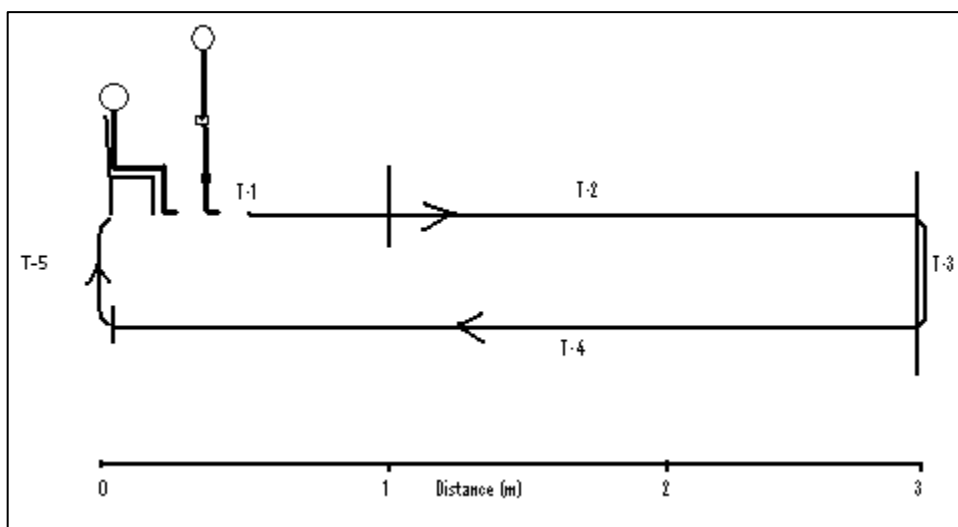

1. Stand up from the chair
2. Walk to the line on the floor at your normal pace
3. Turn around
4. Walk back to the chair at your normal pace
5. Sit down again

On “Go,” begin timing.

The time interval between starting and stopping the watch provides the overall time for the test. The stopwatch also records the interval between each phase/lap of the test. The Phases of the test are as follows:

- Lap 1. Time taken to rise out of the chair and travel to the 1 meter mark (T-1)
- Lap 2. Time taken to travel the remaining 2 meter (T-2)
- Lap 3. Time taken to turn and move back to the 3 meter mark (T-3)
- Lap 4. Time taken to travel back to the starting position (T-4)
- Lap 5. Time taken to sit down (T-5)

SOURCE: Adapted from Podsiadlo and Richardson (1991).



## Appendix J Proprioception Questionnaire

### 1. Do you think there was a delay in responding to the platform movement?

Group Response	Taiji Group (n=16)		Control Group (n=16)	
	Pre test	Post test	Pre test	Post test
Delay	5	5	5	8
No-Delay	11	11	11	8

### 2. Which direction you detected more easily; forward or backward?

Group Response	Taiji Group (n=16)		Control Group (n=16)	
	Pre test	Post test	Pre test	Post test
Forward	9	10	7	9
Backward	7	6	10	6

### 3. Did the direction cue help you in determining the platform movement?

Group Response	Taiji Group (n=16)		Control Group (n=16)	
	Pre test	Post test	Pre test	Post test
Yes	13	13	12	13
No	3	3	4	3

### 4. Where did you felt the movement?

Group Response	Taiji Group (n=16)		Control Group (n=16)	
	Pre test	Post test	Pre test	Post test
Ankle/feet	13	15	12	13
Body/trunk sway	3	1	4	3

## Appendix K

### 30-second Chair Stand Test

**Participant:** \_\_\_\_\_ **Date:** \_\_\_\_\_ **Time:** \_\_\_\_\_ **AM/PM**

**Purpose:** To test leg strength and endurance

**Equipment:**

- Chair with a straight back without arm rests (seat 17” high).
- A stopwatch

**Instructions to the participant:**

Sit in the middle of the chair.

1. Place your hands on the opposite shoulder crossed at the wrists.
2. Keep your feet flat on the floor.
3. Keep your back straight and keep your arms against your chest.
5. On “Go,” rise to a full standing position and then sit back down again.
6. Repeat this for 30 seconds.

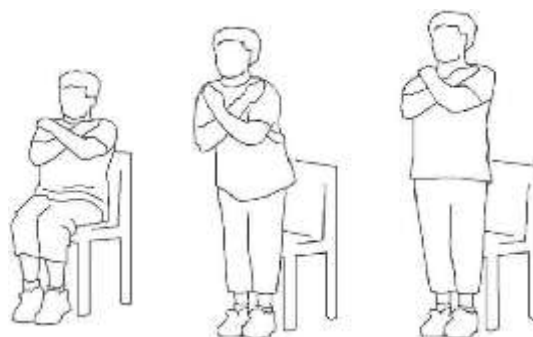

On “Go,” begin timing.

If the patient must use his/her arms to stand, stop the test. Record “0” for the number and score.

Count the number of times the patient comes to a full standing position in 30 seconds.

If the patient is over halfway to a standing position when 30 seconds have elapsed, count it as a stand.

Record the number of times the patient stands in 30 seconds.

SOURCE: Adapted from Jones and Rikli (1999).

## Appendix L



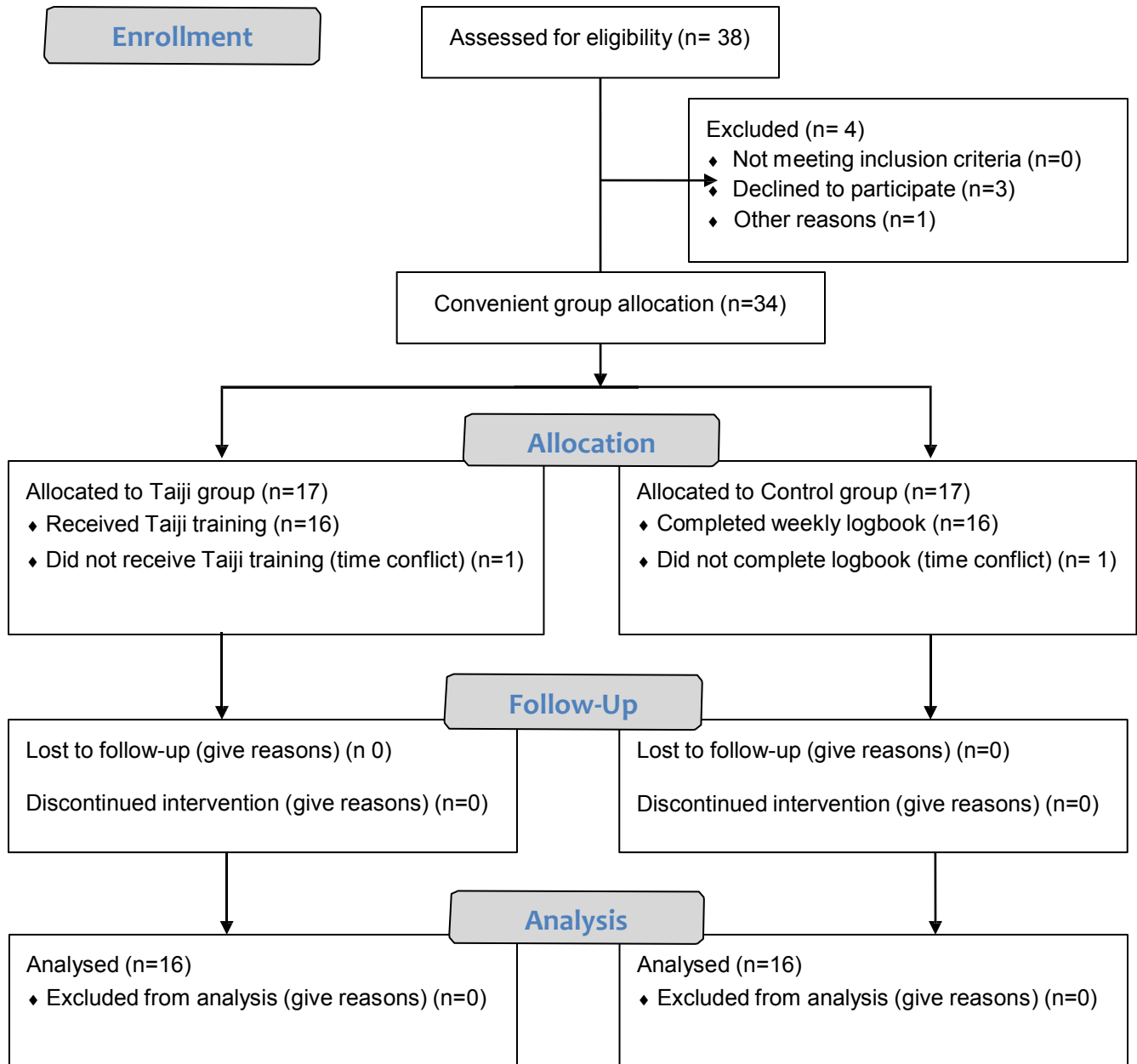

### Study Design

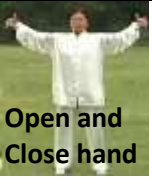

**Appendix M**  
**Sample Weekly Activity Logbook (Taiji Group)**

Participant Name: \_\_\_\_\_

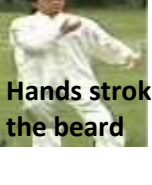
week: \_\_\_\_\_

Date Activity	Monday	Tuesday	Wednesday	Thursday	Friday	Saturday	Sunday
 Raise Up and Press down	Yes No .....min	Yes <input type="radio"/> No <input type="radio"/> .....min	Yes No .....min	Yes <input type="radio"/> No <input type="radio"/> .....min	Yes No .....min	Yes <input type="radio"/> No <input type="radio"/> .....min	Yes No .....min
 Open and Close hand	Yes No .....min	Yes <input type="radio"/> No <input type="radio"/> .....min	Yes No .....min	Yes <input type="radio"/> No <input type="radio"/> .....min	Yes No .....min	Yes <input type="radio"/> No <input type="radio"/> .....min	Yes No .....min
 Presenting the Ball	Yes No .....min	Yes <input type="radio"/> No <input type="radio"/> .....min	Yes No .....min	Yes <input type="radio"/> No <input type="radio"/> .....min	Yes No .....min	Yes <input type="radio"/> No <input type="radio"/> .....min	Yes No .....min
 Hands stroke the beard	Yes No .....min	Yes <input type="radio"/> No <input type="radio"/> .....min	Yes No .....min	Yes <input type="radio"/> No <input type="radio"/> .....min	Yes No .....min	Yes <input type="radio"/> No <input type="radio"/> .....min	Yes No .....min
 Crane flying in the sky	Yes No .....min	Yes <input type="radio"/> No <input type="radio"/> .....min	Yes No .....min	Yes <input type="radio"/> No <input type="radio"/> .....min	Yes No .....min	Yes <input type="radio"/> No <input type="radio"/> .....min	Yes No .....min
 Qi to the dentian	Yes No .....min	Yes <input type="radio"/> No <input type="radio"/> .....min	Yes No .....min	Yes <input type="radio"/> No <input type="radio"/> .....min	Yes No .....min	Yes <input type="radio"/> No <input type="radio"/> .....min	Yes No .....min
<b>Other Exercises</b> (what kind of exercise and for how long)							

## Sample Weekly Physical Activity Logbook for Control Group

Participant Name:

Week:

Date	Monday	Tuesday	Wednesday	Thursday	Friday	Saturday	Sunday
<b>Activity</b>	<b>Yes</b>	<b>Yes</b> ○	<b>Yes</b>	<b>Yes</b> ○	<b>Yes</b>	<b>Yes</b> ○	<b>Yes</b>
	<b>No</b>	<b>No</b> ○	<b>No</b>	<b>No</b> ○	<b>No</b>	<b>No</b> ○	<b>No</b>
<b>Walking</b> (When and for how long)	<b>M</b> <b>A</b> <b>N</b> .....min	<b>M</b> ○ <b>A</b> ○ <b>N</b> ○ .....min	<b>M</b> <b>A</b> <b>N</b> .....min	<b>M</b> ○ <b>A</b> ○ <b>N</b> ○ .....min	<b>M</b> <b>A</b> <b>N</b> .....min	<b>M</b> ○ <b>A</b> ○ <b>N</b> ○ .....min	<b>M</b> <b>A</b> <b>N</b> .....min
<b>Swimming</b> (When and for how long)	<b>M</b> <b>A</b> <b>N</b> .....min	<b>M</b> ○ <b>A</b> ○ <b>N</b> ○ .....min	<b>M</b> <b>A</b> <b>N</b> .....min	<b>M</b> ○ <b>A</b> ○ <b>N</b> ○ .....min	<b>M</b> <b>A</b> <b>N</b> .....min	<b>M</b> ○ <b>A</b> ○ <b>N</b> ○ .....min	<b>M</b> <b>A</b> <b>N</b> .....min
<b>Housekeeping</b> (When and for how long)	<b>M</b> <b>A</b> <b>N</b> .....min	<b>M</b> ○ <b>A</b> ○ <b>N</b> ○ .....min	<b>M</b> <b>A</b> <b>N</b> .....min	<b>M</b> ○ <b>A</b> ○ <b>N</b> ○ .....min	<b>M</b> <b>A</b> <b>N</b> .....min	<b>M</b> ○ <b>A</b> ○ <b>N</b> ○ .....min	<b>M</b> <b>A</b> <b>N</b> .....min
<b>Other Exercises</b> (what kind of exercise and for how long)	<b>M</b> <b>A</b> <b>N</b> .....type .....min	<b>M</b> ○ <b>A</b> ○ <b>N</b> ○ .....type .....min	<b>M</b> <b>A</b> <b>N</b> .....type .....min	<b>M</b> ○ <b>A</b> ○ <b>N</b> ○ .....type .....min	<b>M</b> <b>A</b> <b>N</b> .....type .....min	<b>M</b> ○ <b>A</b> ○ <b>N</b> ○ .....type .....min	<b>M</b> <b>A</b> <b>N</b> .....type .....min

Note: **M**= morning, **A**= afternoon, **N**= night

Independent sample t-test pre-intervention both group.

Postural control dependent variables	t	df	Sig. (2-tailed)
AP eyes-open (cm)	-0.767	30	.449
AP eyes-closed (cm)	-0.668	30	.509
AP balance-space(cm)	.449	30	.657
ML eyes-open (cm)	-0.684	30	.499
ML eyes-closed (cm)	-0.964	30	.343
ML balance-space(cm)	-0.379	30	.708
AS eyes-open (cm <sup>2</sup> )	-1.070	30	.293
AS eyes-closed (cm <sup>2</sup> )	-0.982	30	.334
AS balance-space(cm <sup>2</sup> )	.013	30	.990
PL eyes-open (cm)	.460	30	.649
PL eyes-closed (cm)	-0.119	30	.906
PL balance-space(cm)	-0.256	30	.800
ATGUG total	-1.144	30	.262
ATGUG 1	.404	30	.687
ATGUG 2	-.374	30	.711
ATGUG 3	-1.149	30	.260
ATGUG 4	-1.487	30	.147
ATGUG 5	-.764	30	.451
Chair Stand	.000	30	1.00
Forward angle	1.18	30	.248
Backward angle	.825	30	.416
Pre study Taiji experience	.57	30	.574

### Appendix P

*ICC coefficient of the proprioception measures from pre and post test for Taiji and control group.*

Dependent variable		Taiji group (n=16)		Control group (n=16)	
		Pre test	Post test	Pre test	Post test
Proprioception	Forward angle	.84	.85	.93	.89
	Backward angle	.77	.81	.62	.71

### Appendix Q

*ICC coefficient of the ATGUG measures from pre and post test for Taiji and control group.*

Dependent variable		Taiji group (n=16)		Control group (n=16)	
		Pre test	Post test	Pre test	Post test
ATGUG	Total time	.83	.96	.94	.99
	ATGUG time 1	.16	.77	.78	.86
	ATGUG time 2	.68	.63	.94	.84
	ATGUG time 3	.50	.65	.82	.92
	ATGUG time 4	.78	.91	.87	.95
	ATGUG time 5	.57	.67	.83	.64



### Appendix R

*ICC coefficient of the quiet standing eyes open measures from pre and post test for Taiji and control group.*

Dependent variable		Taiji group (n=16)		Control group (n=16)	
		Pre test	Post test	Pre test	Post test
Quiet Standing Eyes Open	AP (cm)	.62	.66	.87	.75
	ML (cm)	.65	.87	.88	.53
	AS (cm <sup>2</sup> )	.61	.68	.84	.65
	PL (cm)	.90	.81	.92	.85

### Appendix S

*ICC coefficient of quiet standing eyes closed measures from pre and post test for Taiji and control group.*

Dependent Variable		Taiji group (n=16)		Control group (n=16)	
		Pre test	Post test	Pre test	Post test
Quiet Standing Eyes Closed	AP (cm)	.41	.76	.90	.81
	ML (cm)	.70	.85	.92	.76
	AS (cm <sup>2</sup> )	.74	.89	.94	.84
	PL (cm)	.90	.87	.96	.88

### Appendix T

*ICC coefficient of balance space measures from pre and post test for Taiji and control group.*

Dependent variable		Taiji group (n=16)		Control group (n=16)	
		Pre test	Post test	Pre test	Post test
Balance Space	AP (cm)	.93	.91	.97	.96
	ML (cm)	.89	.84	.95	.95
	AS (cm <sup>2</sup> )	.97	.92	.97	.96
	PL (cm)	.97	.91	.94	.90