

# **Simulation-based Modelling of the Unpaved Road Deterioration and Maintenance Program in Heavy Construction and Mining Sectors**

by

**Musa Ince**

A thesis

submitted to the Faculty of Graduate Studies  
in partial fulfilment of the requirements for the  
Degree of Master of Science

in

Civil Engineering

Supervisor

**Ehsan Rezazadeh Azar**

Associate Professor – Dept. of Civil Engineering

Lakehead University

Thunder Bay, Ontario

June 2019

© Musa Ince, 2019

## **Author's Declaration**

I hereby declare that I am the sole author of the thesis. This is a true copy of the thesis, including any required final revisions, as accepted by my examiners.

I understand that my thesis may be made electronically available to the public.

## **Abstract**

Saving cost is a significant factor in the successful operation of heavy civil engineering, such as highway and dam construction, and mining projects, which can be achieved through the reduction of operating costs in large projects. In particular, earthmoving operations form a large portion of these projects, and some of the main components of the earthmoving operating cost are fuel, parts, and tires costs, which directly depend on the quality of the unpaved access roads in the field. This study aims at developing a simulation-based model which dynamically estimates the Roughness Defect Score (RDS) of the road (performance of the road condition) as the traffic increases and provides an optimal maintenance management program based on the affected cost factors using Symphony.Net modelling environment. Symphony.Net is a useful tool for the simulation because it provides an overview of the system's performance in cyclic and long-term operations. This model uses a stochastic approach to calculate the road resistance and the frequency of maintenance, by considering the variations in nondeterministic variables, such as speed and hauled loads. Also, a Markov model-based algorithm is being incorporated in the system to provide more realistic modelling of the road deterioration over time. Markov modelling involves discrete-event transitions, which model's road deterioration from a state to another state over time. Comparison of these three modelling methods (deterministic, stochastic- Monte Carlo and Stochastic- Markov chain modelling) is demonstrated in this study. Constant values were used for the deterministic modelling, probability distributions were used for the Monte Carlo Simulation, and transition matrices were used for the Markov chain modelling. Based on the results, the stochastic modelling was able to provide reliable vehicle operating cost (VOC), optimum frequency of maintenance, and road deterioration for ongoing or future cases.

## **Acknowledgements**

Foremost, I would like to express my sincere gratitude to my advisor Prof. Ehsan Rezazadeh Azar for accepting to be my supervisor and guiding me during the two years in Lakehead University and the continuous support of my master study and research, for his patience, motivation, enthusiasm and immense knowledge. His guidance helped me in all the time of research and writing of this thesis.

Then, I would like to express my sincere thanks to Professor Jian Deng for his valuable guidance during the first year of my master study and being my advisory committee member with enduring advice. I would like to appreciate the Graduate Coordinator of the engineering department, Professor Sam Salem and Professor Ehsan Behzadfar involved in the thesis seminar and provided valuable feedback.

I would also like to express my thanks to all my friends and faculty colleagues for their encouragements. Especially Arsalan Mostaani and Navid Torkanfar, who is always by my side. Without their support, I could not complete this program successfully.

Finally, I would like to extend my entire appreciation to my family for encouraging me to study abroad and providing me with mental support and endless love. Especially my sister Sevda Ince, who is supporting me all the time.

# Table of contents

<b>Author's Declaration .....</b>	<b>II</b>
<b>Abstract.....</b>	<b>III</b>
<b>Acknowledgements .....</b>	<b>IV</b>
<b>List of Figures.....</b>	<b>VII</b>
<b>List of Tables.....</b>	<b>IX</b>
<b>List of Abbreviations.....</b>	<b>X</b>
<b>Chapter 1 : Introduction .....</b>	<b>1</b>
<b>1.1. Background and Motivation .....</b>	<b>1</b>
<b>1.2. Objectives of the Study .....</b>	<b>3</b>
<b>1.3. Research Methods.....</b>	<b>3</b>
<b>1.4. Outline of the Thesis .....</b>	<b>4</b>
<b>Chapter 2 : Literature Review.....</b>	<b>5</b>
<b>2.1. Rolling Resistance (RR).....</b>	<b>5</b>
2.1.1. Rolling Resistance Force.....	7
2.1.2. Road Surface Conditions.....	9
2.1.3. Rolling Resistance due to Surface Condition .....	14
<b>2.2. International Roughness Index and Roughness Defect Score .....</b>	<b>16</b>
<b>2.3. Modelling of Rolling Resistance .....</b>	<b>19</b>
<b>2.4. Vehicle Operating Costs in Earthmoving Operations .....</b>	<b>22</b>
2.4.1. Fuel Consumption .....	22
2.4.2. Tire Cost Model .....	25
2.4.3. Tire Inflation (Tire Response).....	28
<b>2.5. Operational Mistakes.....</b>	<b>29</b>
<b>2.6. Maintenance Management Strategy (MMS).....</b>	<b>30</b>
2.6.1. Vehicle Maintenance Cost Models .....	34
2.6.2. Road Maintenance Cost Model.....	35
<b>2.7. Dust Effects.....</b>	<b>37</b>
<b>2.8. Using a Markov Model for Maintenance of Unpaved Roads .....</b>	<b>38</b>
<b>2.9. Role of Simulation in Heavy Construction and Mining Industry .....</b>	<b>40</b>
<b>Chapter 3 : Methodology .....</b>	<b>43</b>
<b>3.1. Deterministic Modelling.....</b>	<b>44</b>
3.1.1. Fuel Consumption .....	46
3.1.2. Tire Wear Estimation .....	48
3.1.3. Parts Consumption .....	49
<b>3.2. Monte Carlo Stochastic Modeling .....</b>	<b>50</b>
3.2.1. Estimation of the Cost of Road Maintenance .....	66
<b>3.3. Markov Chain Stochastic Modelling.....</b>	<b>68</b>
<b>Chapter 4 : Results.....</b>	<b>74</b>

<b>4.1. Case Study</b> .....	<b>74</b>
<b>4.2. Deterministic Model Results</b> .....	<b>75</b>
4.2.1. Fuel Consumption Estimation .....	78
4.2.2. Tire Wear Estimation .....	81
4.2.3. Part Consumption Estimation .....	83
4.2.4. Maintenance Cost Estimation .....	85
<b>4.3. Stochastic Modelling Results</b> .....	<b>87</b>
<b>4.4. Markov Modelling Results</b> .....	<b>94</b>
4.4.1. Comparison of VOC Results based on Different Running Counts .....	99
<b>Chapter 5 : Conclusion</b> .....	<b>102</b>
<b>5.1. Thesis Finding</b> .....	<b>102</b>
<b>5.2. Limitation</b> .....	<b>104</b>
<b>5.3. Recommendations for Future Research</b> .....	<b>105</b>
<b>References</b> .....	<b>106</b>
<b>Appendix</b> .....	<b>110</b>

## List of Figures

Figure 1. Schematic view of the methods of this research project.....	4
Figure 2. Forces acting on a rolling tire (Jackson et al., 2011) .....	8
Figure 3. Forces acting on a rolling wheel on soil (Plackett, 1985) .....	9
Figure 4. Predicted variation of functionality for original and optimised wearing course materials (Thompson and Visser, 2000) .....	12
Figure 5. Road surface condition with days between road maintenance services (Thompson and Visser, 2006) .....	13
Figure 6. An integrated haul road design and management system (Thompson and Visser, 2006) .....	14
Figure 7. The ranges in wavelength for varying types of roughness (Sandberg, 2010).....	15
Figure 8. Pavement texture and roughness wavelengths and their effect on vehicle performance (Jameson, 2011) .....	16
Figure 9. Correlation between actual data and rolling resistance estimation based on <i>RDS</i> model (Thompson and Visser, 2003) .....	20
Figure 10. A model for fuel consumption (Greenwood et al., 2003) .....	24
Figure 11. Haul truck tire consumption model in comparison to other models (Thompson and Visser, 2003) .....	26
Figure 12. Load distribution in an off-highway dump truck based on Thompson and Visser 1997.....	27
Figure 13. Reduction in tire life (Woodman and Cutler, 2002) .....	27
Figure 14. Minimum total cost solution based on road maintenance frequency and vehicle operating costs ( <i>VOC</i> ) (Thompson and Visser, 2003).....	31
Figure 15. Pavement strain theory related to operational intensity and maintenance requirements (Thompson, 2011) .....	32
Figure 16. Integration of a real-time CTM system with existing mine communication and asset management systems (Thompson and Visser, 2006).....	34
Figure 17. Comparison of different haul truck parts cost models (Thompson and Visser, 2003) .....	35
Figure 18. The productivity of a motor grader during routine haul road maintenance operations (Thompson and Visser 2006).....	36
Figure 19. Typical haul road design components (Thompson and Visser, 2007) .....	37
Figure 20. Prediction of pavement condition based on its age (Ortiz-Garcia et al., 2006) .....	39
Figure 21. A graphical view of the model of an earthmoving operation in CYCLONE (Martinez and Ioannou, 1999) .....	41
Figure 22. Stochastic model for <i>VOC</i> and maintenance in Symphony.Net 4.6.....	51
Figure 23. Determination of trucks number .....	53
Figure 24. Chart of Fuel.....	62
Figure 25. Motor Grader moldboard position (Caterpillar Performance Handbook Edition 36).....	67
Figure 26. Graphical view of the dynamic model in Symphony.Net 4.6.....	70
Figure 27. Deterministic model results for <i>RDS</i> and <i>RR</i> .....	76
Figure 28. New results for <i>RR</i> and <i>RDS</i> based on the increased controllable parameters .....	77
Figure 29. New results for <i>RR</i> and <i>RDS</i> based on increased uncontrollable parameters .....	78
Figure 30. Fuel consumption on each hauling and returning trip.....	79
Figure 31. Fuel consumption per trip based on rolling resistance.....	80

Figure 32. Fuel consumptions at different speed limits .....	81
Figure 33. Tire wear cost per truck in each cycle.....	82
Figure 34. Tire wear cost based on RDS per trip .....	82
Figure 35. Part consumption based on the working day .....	84
Figure 36. Part consumptions for each truck and per trip .....	84
Figure 37. VOC estimation using deterministic modelling .....	85
Figure 38. The optimal frequency of maintenance service in the deterministic model.....	86
Figure 39. Stochastic model vehicle fuel cost results .....	87
Figure 40. Stochastic model vehicle operating cost (VOC).....	88
Figure 41. Stochastic Model VOC for Normal Distribution Type .....	89
Figure 42. Fuel consumption range after increasing speed.....	90
Figure 43. VOC results after increasing speed limits .....	90
Figure 44. Fuel consumptions after increasing speed ranges .....	91
Figure 45. VOC after increasing the speed ranges.....	92
Figure 46. Fuel consumptions with maintenance at RDS 50.....	93
Figure 47. VOC results with maintenance at RDS 50 .....	93
Figure 48. Comparison of the total cost in different maintenance scenarios .....	94
Figure 49. VOC results based on the transition matrix .....	95
Figure 50. VOC results based on the updated (better) transition matrix values .....	96
Figure 51. VOC results based on the excellent condition values in transition matrix .....	97
Figure 52. VOC results based on the poor condition values in transition matrix .....	98
Figure 53. VOC Analysis for Different Conditions in the Markov Model.....	99
Figure 54. Different fuel consumptions based on the different running numbers.....	101



## List of Tables

Table 1. Rolling resistance coefficients for various tires and surfaces (Taborek, 1957) .....	11
Table 2. Description of degrees of <i>RDS</i> (Thompson and Visser, 1997) .....	17
Table 3. Guidance on the subjective assessment of <i>IRI</i> for unpaved roads (The World Bank, 1999) .....	18
Table 4. Typical vehicle speed limits (Woodman and Cutler, 2002) .....	28
Table 5. List of variables used in Symphony.NET 4.6 .....	52
Table 6. Summary of nodes used in the stochastic model.....	54
Table 7. List of additional variables used in Symphony.NET 4.6 for the Markov Modelling.....	69
Table 8. Summary of the node functions used in the dynamic model .....	71
Table 9: Summary of assumed parameter values .....	75
Table 10. Parameters' values used to estimate fuel consumption.....	79
Table 11. Summary of parameter values for part consumption analysis.....	83
Table 12. Maintenance parameters used to calculate maintenance cost.....	86
Table 13: A sample transition matrix values .....	95
Table 14: Transition matrix values after improvement .....	96
Table 15: Transition matrix values in excellent condition.....	97
Table 16: Transition matrix values in poor condition .....	98
Table 17. Sample transition matrix values.....	103
Table 18. <i>RDS</i> and <i>RR</i> values for <i>VOC</i> of Deterministic values. ....	110
Table 19. Total <i>VOC</i> for the Deterministic Model .....	110
Table 20. Total <i>VOC</i> for the Deterministic Model based on the <i>MMS</i> . ....	111
Table 21. Total <i>VOC</i> for the Stochastic Model based on the Simulation Run.....	111
Table 22. Total <i>VOC</i> for the Stochastic Model based on the <i>MMS</i> . ....	111
Table 23. Total <i>VOC</i> for the Dynamic Model .....	112
Table 24. Total <i>VOC</i> for the Dynamic Model based on the <i>MMS</i> . ....	112

## List of Abbreviations

ARRB	Australian Roads Research Board
CBR	California bearing ratio
FCF	Favorable total resistance exists (i.e. $GR + RR < 0\%$ ), the associated fuel consumption
FCU	Unfavorable total resistance exists, fuel consumption
FWD	Falling Weight Deflectometer
GC	Grading Coefficient
GMW	Gross machine weight
GPS	Global Positioning System
GR	Grade resistance
GVM	Gross vehicle mass
IRI	International Roughness Index
MMS	Maintenance management system
MPD	Mean Pavement Depth
PI	Plasticity index
RDS	Roughness defect score
RDSMAX	Maximum roughness defect score
RDSMIN	Minimum roughness defect score
RFID	Radio Frequency Identification
RR	Rolling resistance
SP	Shrinkage product
TR	Total resistance
TW	Tire wear
UVM	Unloaded vehicle mass
VOC	Vehicle operating cost

# **Chapter 1: Introduction**

## **1.1. Background and Motivation**

Haulage of bulk earth material represents a considerable portion of the total cost in surface mining operations (Norgate and Haque 2010) and heavy construction operations, such as highway and dam construction projects (Moselhi and Alshibani 2009). Heavy off-road dump trucks are the main equipment type used to haul material in the earthmoving operations, which operate on haul road networks that could be up to 40 km in length (Thompson and Visser 2003). Unpaved road networks are not usually well-designed and optimally maintained. Most heavy civil engineering and surface mining researchers and operators agree that well-maintained roads are desirable for the efficiency of haulage operations (Coffey et al., 2019). In particular, road surface condition affects three components of vehicle operating cost (VOC), including fuel, tire wear, and parts consumption. Improving road design and maintenance management can reduce truck haulage costs in surface mining, which could be up to 50% of the total operating costs (Thompson and Visser 2003). Haul roads are typically constructed from unbound mine waste or locally available materials and do not typically comply with highway pavement specifications (Thompson and Visser 2003).

Rolling resistance (RR) is an important parameter in operation of heavy trucks, which is the force required to overcome the resistance of a horizontal surface against a rolling mechanism, usually a wheel, to maintain a constant speed. Pavement surface characteristics directly affect the rolling resistance, and rough road surfaces increase the RR and therefore, increase the loss of energy (Hammarstrom et al., 2012). Speed and load are important factors to establish a relationship

between rolling resistance and vehicle operating cost. For example, higher truck speeds reduce tire life and increase road surface deterioration (Hammarstrom et al., 2012).

Road deterioration is a major concern for VOC because deteriorated surfaces have higher roughness and rolling resistance. Road deterioration can be modelled with different approaches, such as deterministic modelling (Thompson and Visser 2003) and discrete-time Markov process (Dekker, 1996). However, Markov chain models were only investigated for deterioration of asphalt pavements, and there is no research effort in the literature for unpaved haul roads. Development of models for deterioration of haulage roads and estimation of VOC can help practitioners to improve the estimation of VOC and plan an effective maintenance system. In particular, it is desirable for the unpaved roads to have the ability to carry the imposed loads without excessive maintenance or early rehabilitation (Thompson and Visser 1997).

All the prior research studies on this area used deterministic methods to model deterioration of the haul roads and estimate VOC, and currently, there is a gap in the literature, where there is no study to apply stochastic modelling to predict road deterioration, vehicle operating costs, and the frequency of maintenance service.

This research project investigates stochastic and dynamic modelling methods to incorporate variations, and the randomness exists in the actual job sites. This thesis presents a maintenance management modelling system, which tracks the rolling resistance of the haul roads based on operational characteristics and time and can propose an optimal maintenance frequency for the haul roads. A case study is presented, which illustrates the potential of the proposed models to manage maintenance and highlights the opportunities to strike a balance between VOC (fuel, tire, and part consumption) and maintenance cost.

## **1.2. Objectives of the Study**

This research aims at modelling and improving efficiency and operation costs in earth material hauling operations by utilizing stochastic and dynamic simulation modelling methods. Thus, it would make it possible to estimate VOC and maintenance costs and find an optimum solution. Three modelling approaches are selected for the analysis and optimization of VOC and maintenance costs. The objectives of the research are as follows:

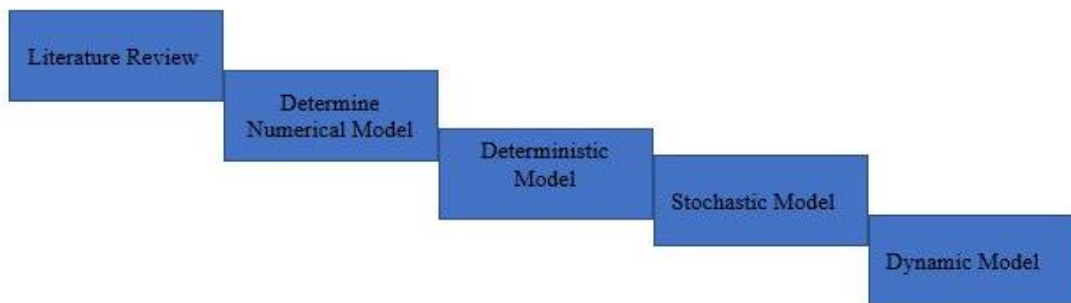
- Develop a deterministic model to estimate VOC and optimal maintenance frequency, using constant values for the affecting parameters
- Develop a stochastic model based on the Monte Carlo Simulation to estimate VOC and optimal maintenance frequency, using probability distribution for the speed and load of trucks
- Lastly, develop a dynamic model based on Markov Chain Modelling, which includes transition matrixes and probabilistic variables.

## **1.3. Research Methods**

The first step of this research is to determine the road surface properties that affect the rolling resistance experienced by haul trucks. The second step of the research studies deterioration of the road surface condition under the operation of haul trucks and investigates vehicle operation cost (VOC) models based on the road surface condition. Quantification of the road surface condition is essential in the modelling stage.

Then, this research investigates three modelling methods, including deterministic, stochastic,

and Markov chains models, to assess road surface deflections and evaluates different maintenance scenarios to determine an optimal maintenance frequency for haulage roads. Simphony.Net 4.6 was used as a modelling platform in this research, which provides the tools needed for stochastic and dynamic modelling and enables developers to implement functions using Visual Basic or C# programming languages. Figure 1 presents a schematic view of the methods in this research project.



**Figure 1. Schematic view of the methods of this research project**

## **1.4. Outline of the Thesis**

This thesis includes five chapters. Chapter 1 introduces the research and its objectives and provides an outline of this research project. Chapter 2 presents the background of the research and current state of knowledge related to rolling resistance and unpaved road conditions, and different types of modelling approach in this area. Data sources used in this study are also discussed in this chapter. Chapter 3 describes the methodology for numerical and simulation models for unpaved road surface deterioration and operating costs, and it provides all the process used for modelling. Chapter 4 discusses deterministic, stochastic, and dynamic modelling results in a set of test scenarios. Chapter 5 (Conclusion and Recommendations) summarizes the research, discusses its contributions and limitations, and suggests recommendations for future research works.

## Chapter 2: Literature Review

This chapter provides background information on the previous research for rolling resistance (*RR*) and hauling vehicle operating cost (*VOC*) in mining and heavy civil engineering operations. Heavy trucks operate on unpaved roads, which could cause different distresses on the haulage road surface due to their speed and load, such as potholes, uneven road surface, rutting, and deterioration of the unpaved roads (Thompson and Visser 2003). These negative effects result in dusting, destruction of the surrounding environment, poor safety, an increase in the *VOC*, especially due to increased fuel, tire, and parts consumption. This chapter explores the relations between rolling resistance and road surface condition and how these effects can be controlled. This chapter also discusses other related ideas, such as the role of speed and the effect of load on road deterioration and describes the effect of maintenance management systems (*MMS*).

### 2.1. Rolling Resistance (*RR*)

Mining and heavy engineering industries process large quantities of bulk materials; therefore, earthmoving equipment is the most critical resources in operation. The required power of the hauling equipment is determined based on two essential factors: Rolling Resistance (*RR*) and Grade Resistance (*GR*). Grade resistance comes from the slope of a road. Thus there is not much that can be done to alter this factor aside from decreasing the slope, which is associated with an immense earthwork cost. *RR* is affected by the surface of the road. Rolling resistance is the resistance of a level surface against steady speed motion of a vehicle, which is also referred to as truck resistance. Unlike *GR*, *RR* can be reduced and controlled with the application of effective maintenance management strategies (*MMS*). Truck resistance occurs where there is friction or

flexing between tire and road surface in the driving mechanism. The resistance also depends on the type and condition of the earth material on which trucks move on. According to the literature, soft surfaces have higher resistance, and hard surfaces such as concrete pavement, offer lower resistance, because tires sink deep in soft surfaces, and this increases the *RR* (Norgate and Haque 2010).

Measuring *RR* could be rather difficult because it depends on various parameters. Parameters can be classified in a few categories, including parameters related to soil, such as plasticity index (*PI*), California Bearing Ratio (*CBR*); parameters related to driving behavior, such as the speed of the truck; and parameters related to the vehicle, such as the weight of the truck. The coast-down test can be used to measure rolling resistance, where the main idea is to measure different variables to estimate *RR* (Coffey et al., 2018). The test can be done by testing different models of tires or different weights of the truck. The test involves coasting a truck down from a known speed to a full stop. Then by measuring the time and distance to stop, it is possible to estimate the total *RR*. In the literature, the driving resistance preferred to the sum of *RR* of each wheel in contact with the ground and any associated losses in the tire's vehicle suspension, bearings, or transmission systems (CENEK et al., 1996).

Traffic energy depends on the road surface conditions, and it has separate affecting parameters such as *RR*, driving resistance, fuel consumption, and depend on individual cases. The condition of the road surface is essential for speed and traffic energy. Lower speeds will decrease energy use and traffic accidents, but they will increase the hauling time. Thus lower speeds usually have more advantages than higher speeds for haulage roads (Hammarström et al., 2012). According to the International Organization for Standardization 2009 (ISO 28580), *RR* is regarded as rolling resistance coefficient ( $R_c$ ), which is the ratio of a vertical load of the wheel to the horizontal force

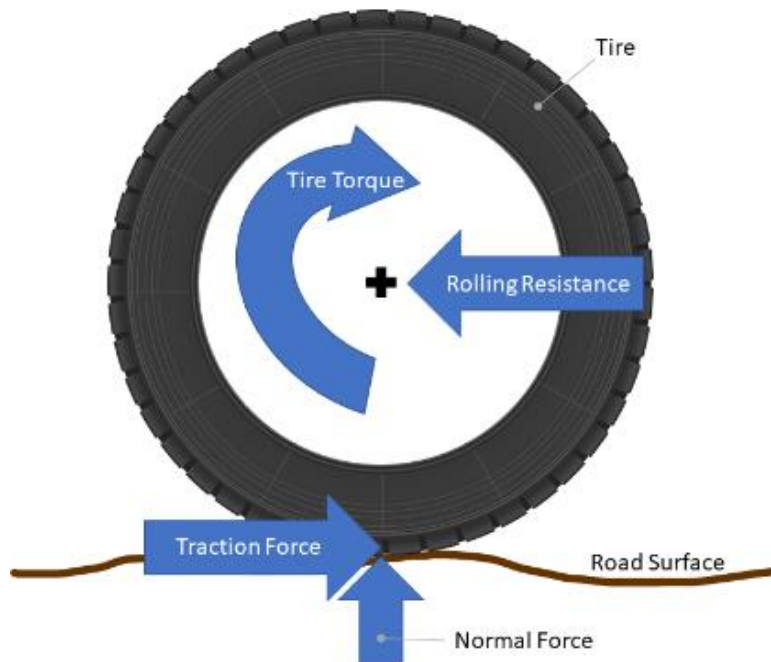


required to sustain a steady-state motion of a wheel, which is presented in Equation 1. This equation gives the relation between tire loads (vertical) and *RR* resistance (horizontal) (Evans et al., 2009). As it is shown in Equation (2.1), ISO 28250 definition of the rolling resistance coefficient can be defined as:

$$R_c = \frac{\textit{Tire Load (kN)}}{\textit{Rolling Resistance Force (N)}} \quad (2.1)$$

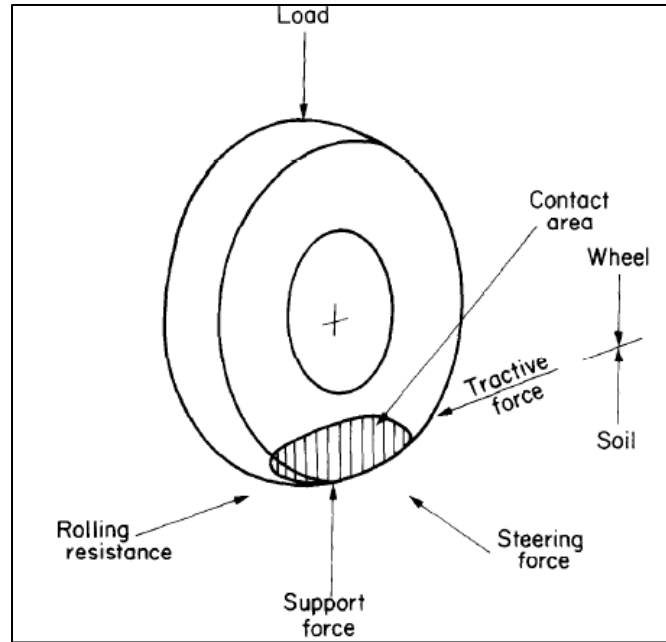
### 2.1.1. Rolling Resistance Force

Mining and heavy civil engineering operations use ultra-heavy dump trucks for earthmoving operations on haul road networks, which are not typically long (10 to 40 km) (Thompson and Visser 2003). In the haulage roads, *RR* depends on different variables such as traffic volume, road design, and material qualities. *RR* is a force, which acts in the opposite direction of travel. Thus, the hauling system loses energy through factors affecting vehicle, tires, and pavement system (Sandberg et al., 2011). The vehicle must move against *RR* in the motion, and the associated forces are provided in Figure 2 (Jackson et al., 2011). *RR* is a form of drive resistance as each tire of the truck touches the ground that which causes energy loss. In the movement, different forces affect the drive resistance, and due to this, it is complicated to calculate their values (Hammarström et al., 2012).



**Figure 2. Forces acting on a rolling tire (Jackson et al., 2011)**

$RR$  is a scalar quantity with the unit  $N/kg$  (Thompson and Visser 2003). The haul roads are expected to enable dump trucks to carry an imposed load to the desired location under different conditions. During the process,  $RR$  is a significant factor that can affect the duration and cost of earthmoving operations. Proper design of haulage roads construction and maintenance of the haulage roads decrease rolling resistance and reduce associated costs, including fuel, spare parts, and tire consumptions. Figure 3 displays different forces applied to a tire while in motion (Plackett, 1985). The contact area represents the contact between soil and tire, which could be complex for pneumatic tires.



**Figure 3. Forces acting on a rolling wheel on soil (Plackett, 1985)**

Three factors affect total rolling resistance ( $RR$ ), which are: vertical soil compaction ( $R_c$ ) which is different from rolling resistance coefficient, horizontal soil displacement ( $R_b$ ), and flexing tire ( $R_t$ ), which is the force occurs between tire and soil, and the entire  $RR$  is equal to the sum of all factors ( $RR = R_c + R_b + R_t$ ). The wheel tires can cause rutting on the soft surfaces under a rectangular plate, but its extent depends on the frictional and cohesive components of the (Plackett, 1985).

### **2.1.2. Road Surface Conditions**

Surface condition in haulage roads has a critical role in  $VOC$  because it has a direct relationship with rolling resistance ( $RR$ ), which affects fuel, tire, and parts consumption. The operating performance of a pavement structure system depends on three items (Thompson and Visser 2006):

1. Structural design: the ability of the road to carry the imposed load without the need for excessive maintenance.

2. Functional design: the ability of the road to provide economical vehicle ride choice
3. Maintenance design: the frequency of wearing course maintenance for a minimum operating and road maintenance cost.

The structural design is related to bearing capacity and strength of the pavement. If the structural design is weak, rolling resistance (*RR*) starts to increase due to the strain/stress response (hysteresis) of pavement material (Jackson et al., 2011). The structural design of the pavement relates to its ability to carry the imposed loads without the need for excessive maintenance or early rehabilitation (Kecojevic et al., 2010). It is necessary to develop a structural design method for haulage roads to improve earthmoving operations. While haulage road pavements design, it uses empirical design method (fail or satisfy) then the haulage road design can be analyzed by trucks (Thompson and Visser 1997).

Selection of wearing course material with low boulder content and adequate cohesion should result in a significant improvement in riding quality. If haulage roads have poor functional performance, safety and operational efficiency will be lower than usual (Britton et al., 2012). Also, the road and vehicle maintenance requirement will be high. Besides, the increasing weight of the truck will result in an accelerated maintenance requirement, and it will render the current pavement design inadequate. Structural and functional designs should be examined together for cost and safety benefits (Thompson and Visser, 2000). This study also showed that pavement stiffness is a critical contributor to the static rolling resistance coefficient (Cenek et al., 2012). *RR* relates to surface coefficients, which was discovered during the 1950s (Taborek, 1957). Based on the study, which is displayed in Table 1, shows that rigid surfaces, such as concrete, have the lowest rolling resistance, and soft surfaces, such as sand, have the highest rolling resistance.

**Table 1. Rolling resistance coefficients for various tires and surfaces (Taborek, 1957)**

Tire Type	Surface		
	Concrete	Medium Hard Soil	Sand
Passenger Car	0.015	0.08	0.3
Truck	0.011	0.06	0.25
Tractor	0.02	0.04	0.2

Energy loss through a load/unload cycle occurring within a pavement structure could be estimated by observation of the hysteresis via tire (stress/strain) under Falling Weight Deflect meter (*FWD*) testing. Rolling resistance has significant differences in energy losses in a rigid and soft surface. Moreover, the *FWD* measures the pavement structure capacity, and it can provide reliable data about energy loss through hauling (loading/ unloading) processes (Schmid et al., 2009). Based on the study, the estimation of the energy lost due to rolling tire could be 70-80% of the maximum energy, which is during *FWD* testing.

There is another study focused on *FWD* testing of pavements and the results showed that the fuel consumption of a truck travelling at 80 km/h was increased 5-10% when driving on asphalt pavement, representing an energy loss approximately four times greater than driving on a cement concrete pavement (Lenngren et al., 2010). The pavement structure has many interdependent parameters, and pavements should be designed based on structural and functional design frameworks. Figure 4 shows the effect of wearing course material and defect score, where two different types of materials used for the research. M1 new wearing course material has higher strength than M1 original wearing course material; haulage roads surface will be defected differently (Thompson and Visser 2000).

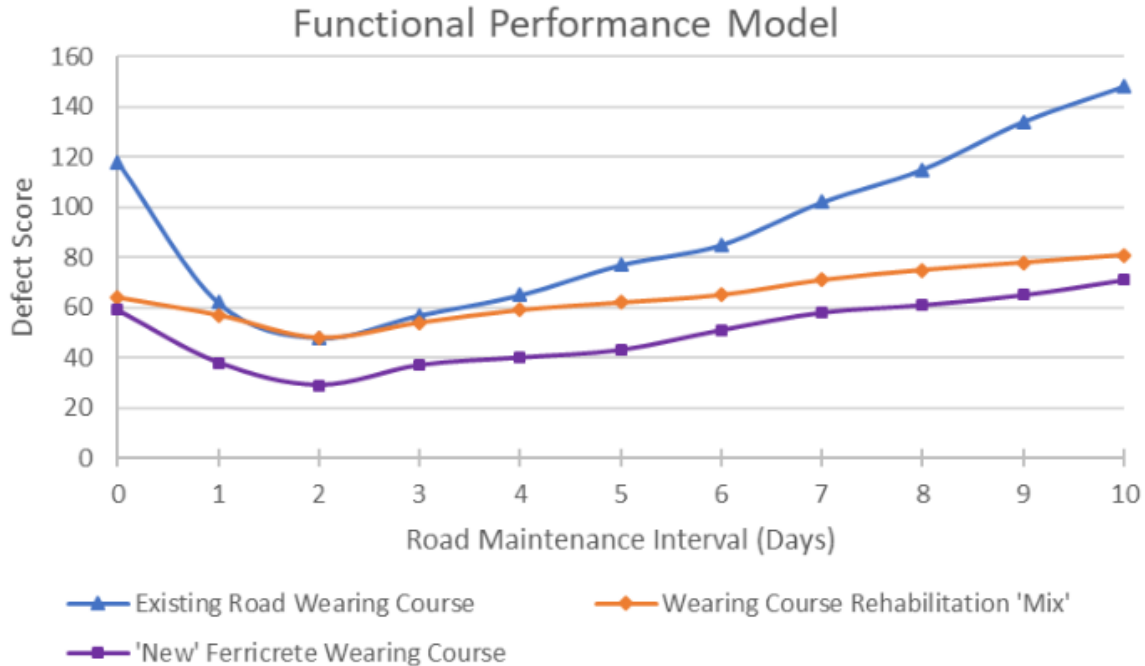


**Figure 4. Predicted variation of functionality for original and optimised wearing course materials (Thompson and Visser, 2000)**

Improving function design of pavement and rebuilding new wearing course material are costly for all the haulage roads. It will exceed the optimal budget, as these roads are temporary in mining and heavy civil engineering projects. Thus, significant investment is not necessary for the functional design of the pavement. However, there is a way to build these roads affordable with local natural earth materials. Also, an advantage of using local natural gravel is its relatively low rolling resistance and a high coefficient of adhesion. Also, this type of roads can be constructed rapidly (Thompson and Visser 2000).

The choice of wearing course material can improve haulage roads condition such as, wet slipperiness, dustiness, tire damage potential, and dry skid resistance defects, which will keep rolling resistance at a minimum level. Thompson and Visser (2016) tested different wearing course materials effect for road maintenance requirements in 2006. There was a comparison of three wearing course materials in a case study: the current road wearing course material, mix, and new

material. Figure 5 demonstrates the relationship between defect score and wearing course material in different road maintenance intervals. Proper wearing course material could reduce defect score by about 50%, which decreases *VOC* significantly (Thompson and Visser 2006).



**Figure 5. Road surface condition with days between road maintenance services (Thompson and Visser, 2006)**

It was proposed that the optimal performance of haul roads includes five major areas, as shown in Figure 6 (Thompson and Visser 2006).

1. Geometric Design: it is about layout and alignment in both vertical and horizontal (incline, decline, cross-fall curve radius). The primary goal is to produce an optimally, efficient and safe geometric design.
2. Structural Design: the goal is to carry imposed load over the design without any support.
3. Functional Design: it is the most suitable choice of selection of wearing course materials,

which requires a minimum functional defect.

4. Maintenance Management Design: optimal frequency of maintenance to reduce *VOC* and road maintenance.
5. Dust Emission Model: it means to decrease dusting for safety and the environment.

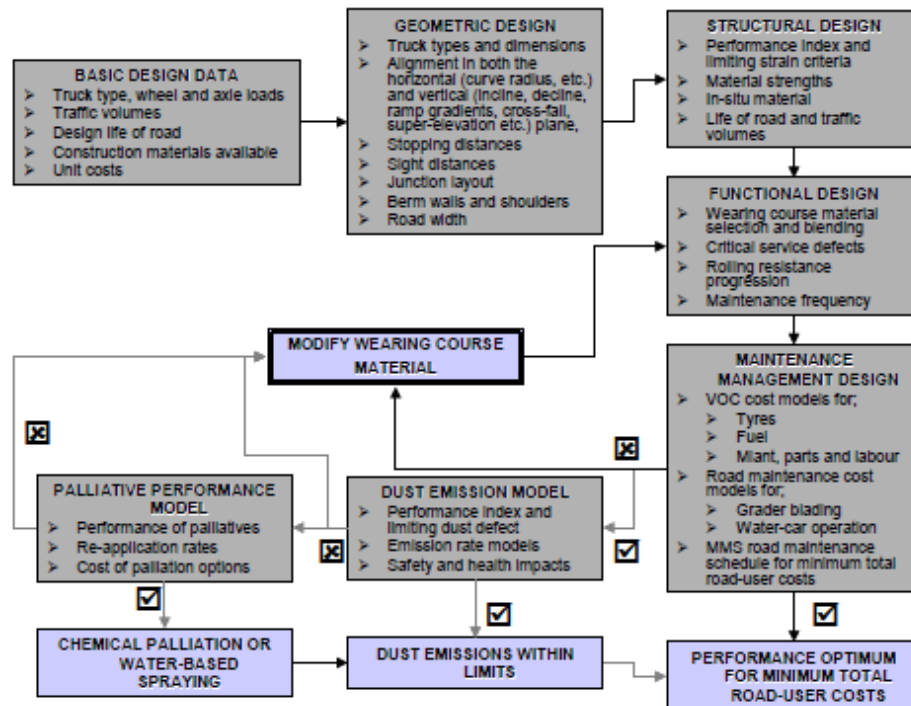


Figure 6. An integrated haul road design and management system (Thompson and Visser, 2006)

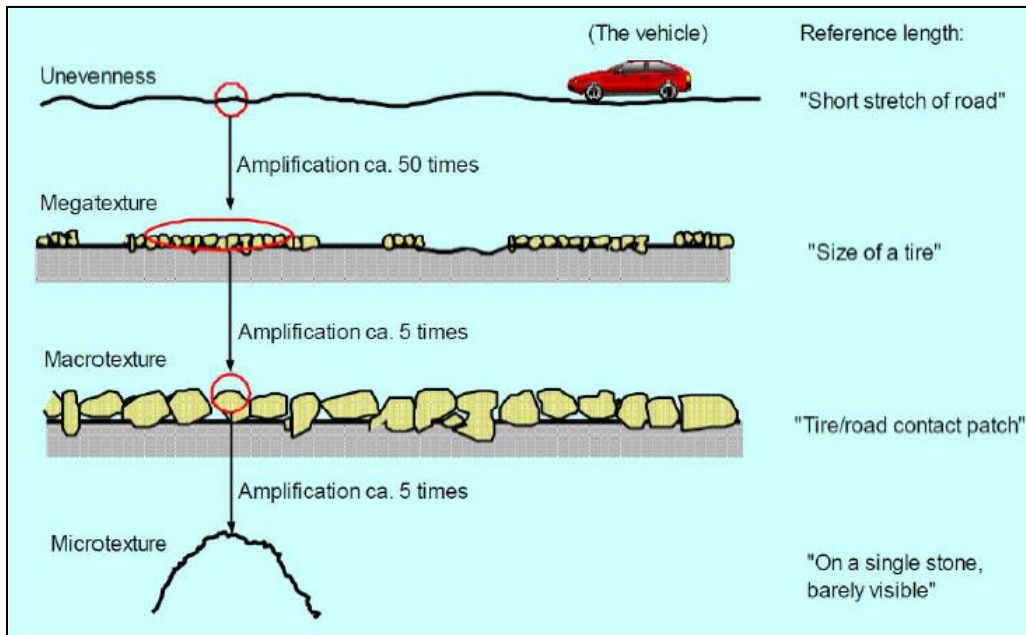
### 2.1.3. Rolling Resistance due to Surface Condition

The condition of a road surface is an important parameter for safety, vehicle operating cost (*VOC*), maintenance cost, the vibration of trucks and noise generation in earthmoving operations.

The interaction between the truck tire and pavement causes a texture in the road surface. The texture is an important parameter to measure the deflection in a pavement surface. Figure 7 illustrates different classes of texture, which highlights the relationship between particle sizes on the surface course and tire deflection (Sandberg, 2010). Texture can be subdivided into three



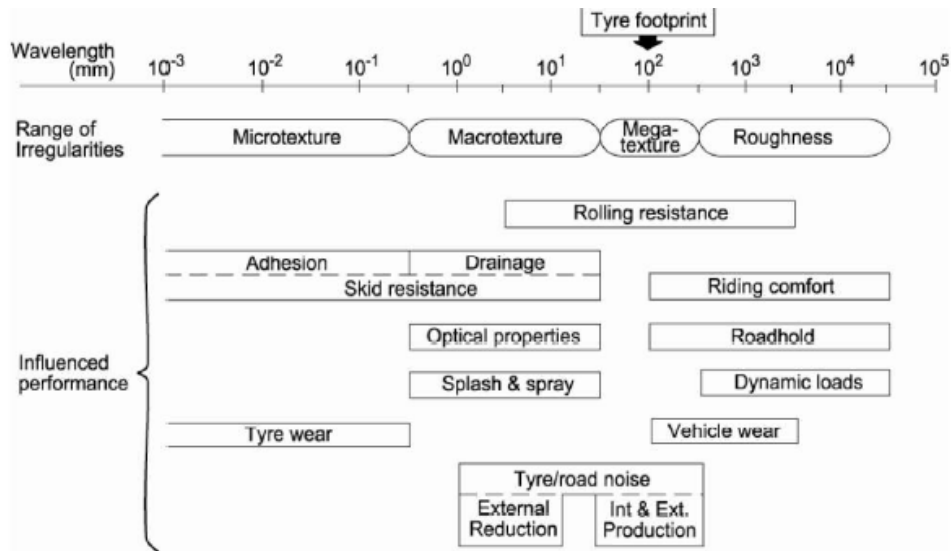
categories: microtexture, macrotexture, and megatexture. Microtexture relates to wavelengths which are less than 0.5 mm (e.g., a single stone). Tire adhesion and skid resistance relate to microtexture, which is significantly important for *RR* (Jameson, 2011). Macrotexture examines wavelengths ranging from 0.5 to 50 mm. Macrotextures are primarily associated with the surface course, tire deflections, and energy loss. A study from Nielsen et al., (2002) demonstrated that the development of 1 mm macrotexture, will increase the speed by 17% while truck speed is at 54 km/h. Another study by Mclean et al. (1998) showed that if the wavelengths are smaller than 10 mm, the noise generation will decrease while driving on the road surface. Moreover, wavelengths larger than 10 mm have been associated with increased truck vibrations and noise generation, while decreasing the ride quality (Mclean et al., 1998).



**Figure 7. The ranges in wavelength for varying types of roughness (Sandberg, 2010)**

Megatextures are the wavelengths between 50 to 500 mm, which represents the size of a tire. They are a significant factor in rolling resistance and result in substantial vibrations. Mclean et al. (1998) demonstrated that the roads with megatexture wavelengths increase fuel consumption by

approximately 9%. Mclean et al. concluded that road maintenance is an effective approach to reduce *VOC* (Mclean et al., 1998). Figure 8 shows the relationship between pavement texture, roughness wavelengths and vehicle performance. This figure shows that significant rolling resistance occurs on macrotextures and megatextures (Jameson, 2011).



**Figure 8. Pavement texture and roughness wavelengths and their effect on vehicle performance (Jameson, 2011)**

## 2.2. International Roughness Index and Roughness Defect Score

There are two main measures to assess unpaved road surface conditions, which could also be used to estimate the rolling resistance of the road surface. The output from these models indicates the level of functional performance of the road, as well as the rate of road defect progression. The first measure is the roughness defect score method (*RDS*). The roughness defect score was developed by considering the propensity of a material to generate surface defects, such as potholes, corrugation, rutting, loose material, and fixed stoniness (Thompson and Visser 2003). The method requires some parameters for estimation of roughness defect score. Table 2 provides the criteria and parameters for visual assessment in the *RDS* method (Thompson and Visser, 1997). The degree

of *RDS* is determined based on vertical, horizontal, and other defects (such as dusting level). This method focuses on haul unpaved roads in mining and heavy civil engineering operations, where low-speed limits are enforced. This method classifies the road surface condition into five categories. Based on the table, if a road condition is classified as degree 1, it means that the road is in perfect condition. However, degree five means that the road is in a very poor condition (Thompson and Visser, 1997).

**Table 2. Description of degrees of *RDS* (Thompson and Visser, 1997)**

Defect	Degree 1	Degree 2	Degree 3	Degree 4	Degree 5
Loose material	Very little loose material, <5 mm depth	5-10 mm	10-20 mm	20-40 mm	>40 mm
Rutting	Difficult to discern unaided, <20mm	20-50mm	50-70 mm	70-90 mm	>90 mm
Potholes	The surface is pockmarked, holes are <50 mm diameter	50-100 mm	100-400 mm	400-800 mm	>800 mm
Dustiness	Dust just visible behind the truck	Dust visible, no oncoming vehicle driver discomfort, good visibility	A notable amount of dust, Windows closed	A significant amount of dust, Visibility is poor	Very dusty and A dangerous level of surrounds

The second method is the international roughness index method (*IRI*), which was established in 1986 by the World Bank. *IRI* can be calculated by obtaining data from road profile deflection (Schoenberg et al., 1995). The *IRI* method includes two major components, which are the speed of vehicle and road deflection to measure the road surface condition. Table 3 shows the indices used in the *IRI* method. The model is more suited for passenger cars used by the public rather than trucks, due to the relatively higher speed limits as indicated in the *IRI* criteria. The table provides speed limits based on the deflection score. Despite the incorporation of vehicle speeds, the method

does not consider major defects, such as dusting and potholes. Therefore, it cannot establish an accurate relationship between haulage road conditions and *VOC* with *IRI* method (Tan et al., 2011). Nielsen et al. (2002) explored the relationship between *IRI* and truck speed. Texture affects truck speed. Results from the study show that with maintenance service improvement of haulage roads with *IRI* of 1 m/km will increase the truck speed by 1.8% while the truck speed at 54km/h (Nielsen et al., 2002).

**Table 3. Guidance on the subjective assessment of *IRI* for unpaved roads (The World Bank, 1999)**

<i>IRI</i> (m/km)	Road Description
1.5 to 2.5	The recently bladed surface of fine gravel or soil surface with excellent longitudinal and transverse profile
3.5 to 4.5	Ride comfortably up to 80-100 km/h, aware of gentle undulations or swaying. Negligible depressions (e.g.<5mm/3mm) and no potholes
7.5 to 9.0	Ride comfortably up to 70-80 km/h but aware of sharp movements and some wheel bounce. Frequent shallow moderate depressions or shallow potholes (e.g. 6-30mm/3m with frequency 5-10 per 50m). Moderate corrugations.
11.5 to 13	Ride comfortably at 50km/h. Frequent moderate transverse depressions (e.g. 20-40mm/3m-5m at frequency 10-20 per 50m) or occasional deep depressions or potholes and strong corrugations.
16 to 17.5	Ride comfortably at 30-40 km/h. Frequent deep, transverse depressions and potholes (e.g. 40-80mm/1.5m at frequency 5-10 per 50m) or occasional very deep depressions. Not possible to avoid all the depressions except the worst.
20 to 22	Ride comfortably at 20-30 km/h. Speeds higher than 40-50 km/h would cause extreme discomfort and possible damage to the car. On a good general profile: frequent deep depressions and /or potholes (e.g. 40-80mm/1.5m at frequency 10-15 per 50m) and occasional very deep depressions. On a poor general profile (e.g. poor earth surface)

### 2.3. Modelling of Rolling Resistance

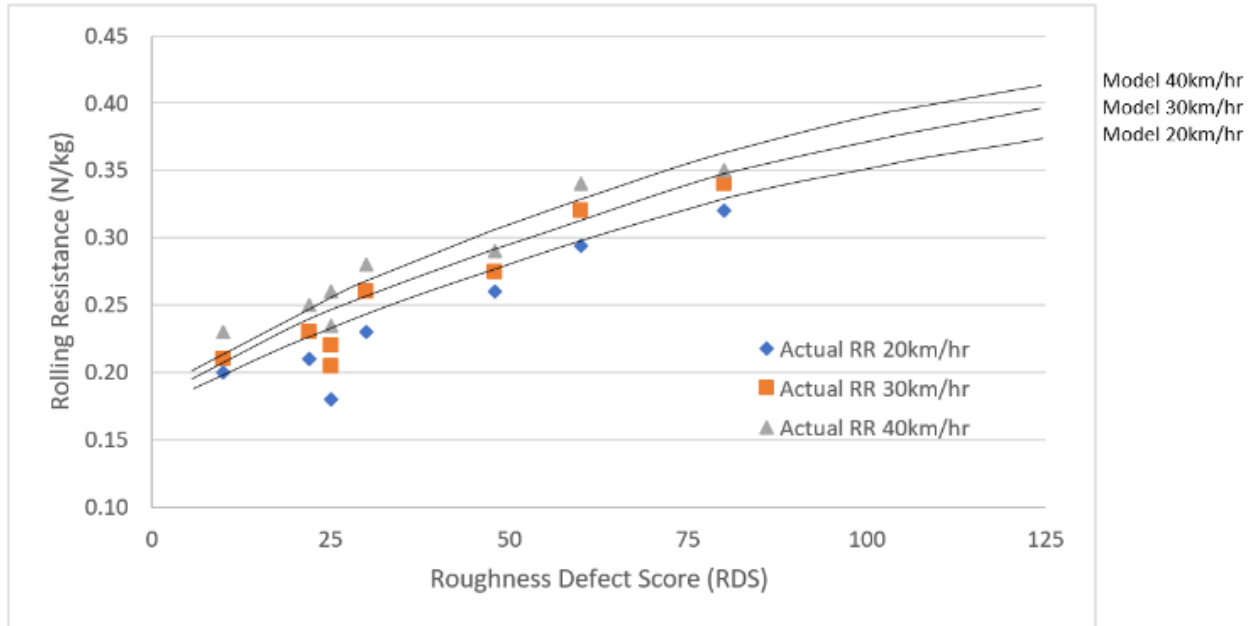
*VOC* is directly affected by pavement conditions and wearing course material affects existing pavement condition, because it is the upper layer of the road surface. For this reason, it is important to examine the relationship between road surface condition and *RR* and to identify affecting independent variables. As discussed before, roughness defect score (*RDS*) is a measure to represent defect condition of unpaved road surfaces (in wearing course layer), and *RDS* affects *RR*. A mathematical model was proposed to establish a relationship between *RDS* and *RR*. There are five different score levels for *RDS*, and *RDSMIN* shows the best condition for a road surface and *RDSMAX* shows the worst condition for the road surface. Values between *RDSMIN* and *RDSMAX* provide other levels of defect scores. A sample model established between *RR* and *RDS*, and as it is presented in equation (2.2) (Thompson and Visser 2003), the relation between *RR* and *RDS* can be defined as:

$$RR = RR_{min} + RDS \cdot \exp(f) \quad (2.2)$$

This equation requires a regression function (*f*) to calculate *RR*. This regression function describes the rate of change in rolling resistance based on the speed of trucks, using a logarithmic transformation method. Figure 9 shows sample *RR* and *RDS* graphs in different truck speeds. As it is presented in this figure, increasing of the *RDS* results in greater *RR* values, thus preference should be given to lowering *RDS*.

In another model proposed by Cenek et al., (2012), difference coefficients were included in estimating *RR* (see Equation (2.3)). *RR* in this model is related to the soil condition. Tires are the main factor in rolling resistance because they have to overcome the rolling resistance. Mass and velocity also affect road surface condition, and these factors are also included in the model

developed by Cenek et al., (2012).



**Figure 9. Correlation between actual data and rolling resistance estimation based on *RDS* model (Thompson and Visser, 2003)**

Moreover, the equation includes a static rolling resistance coefficient. As it is shown in Equation (2.3), rolling resistance force equation can be defined as:

$$FR = M * g(C_o + C_v * V^2) \quad (2.3)$$

There are two types of coefficients in this model. The first one is a speed coefficient ( $C_v$ ), which is related to tire size and vehicle mass. The second one is the static coefficient ( $C_o$ ), which represents the structural capacity of the soil (Cenek et al., 2012). Finding these two numbers can be complicated as they depend on many factors. One of the earliest research efforts to study the relationship between *RR* of the road surface and haulage efficiency was conducted in 1970 (Kaufman, 1977). Based on this research, the model in Equation (2.4) was developed, which provides a general and easy solution to find a relationship between *RR* and the pavement deflection

score. As it is shown in Equation (2.4),  $RR$  relating to weight and penetration depth (According to Caterpillar, 2006) can be defined as:

$$RR = 2\% \text{ of GMW} + 0.6\% \text{ of GMW per cm of tire penetration} \quad (2.4)$$

The main idea is to establish the relationship between the weight of trucks and tire penetration to estimate  $RR$ . Widodo et al. (2009) proposed that  $RR$  is associated with the vertical grade of the road, and two models were proposed. As these are shown in Equation (2.5), rolling resistance function of grades less than 8% and in Equation (2.6). Rolling resistance function of grades of 8% and greater can be defined as:

$$RR = 0.115 \left[ \frac{W^{6.96}}{P \cdot A} \right]^{0.17} \quad (2.5)$$

$$RR = 0.116 \left[ \frac{W^{4.67}}{P^{0.5} \cdot G} \right]^{0.24} \quad (2.6)$$

There are some other research efforts which used the International Roughness Index ( $IRI$ ) to estimate  $RR$ , such as the recent study by Coffey et al. (2018). This method considers all deflections as a general and speed limit does not reflect a realistic number for unpaved roads. Terrestrial laser scanning was used in this study to measure the deflection values of the road surfaces, and then these values are put into a formula (shown in Equation (2.7)) to estimate the  $IRI$  of the road surface (Coffey et al., 2018). As it is shown in Equation (2.7), Estimation of  $IRI$  can be defined as:

$$IRI = 0.4 + (Var3)^{0.5} \quad (2.7)$$

## 2.4. Vehicle Operating Costs in Earthmoving Operations

### 2.4.1. Fuel Consumption

Fuel consumption is an important cost factor in earthmoving operations and road maintenance cost models. Fuel consumption models can be developed to analyse different operation scenarios. Since there are many interdependent variables, development of a fuel consumption model is a complex task. However, RR is the most critical factor for fuel consumption of hauling trucks and other *VOC*, such as tire wear and vehicle parts costs. Roughness defect score is an important variable to estimate fuel consumption of earthmoving equipment. Fuel consumption depends on the vehicle weight, speed, and total resistance (*TR*) of the unpaved road. Total resistance includes two major components: rolling resistance and grade resistance (*GR*). Mathematical models were developed for the fuel consumption of heavy dump trucks, as shown in Equations (2.8) and (2.9). Favorable fuel consumption model and Unfavorable fuel consumption model (Thompson and Visser 2003) respectively can be defined as:

$$\begin{aligned} & \text{Favorable Fuel Consumption (FCF)} \\ & \text{In favorable cases, total resistance should be } RR + GR < 0\%. \\ & FCF = -3.575 + UVM(0.092 - 0.016DV) + 0.0017L.GVM \end{aligned} \quad (2.8)$$

$$\begin{aligned} & \text{(FCU) Unfavorable total resistance} \\ & \text{In unfavorable cases, total resistance should be } RR + GR > 0\% \\ & FCU = 1.02 + UVM.V(296.TRU + 4.5.V) \\ & \quad + L.GVM.V(246.TRU + 0.027.V2) * 10^{-5} \end{aligned} \quad (2.9)$$

Differences between two equations, in unfavorable cases, total resistance should be  $RR + GR > 0\%$ , and in favorable cases, total resistance should be  $RR + GR < 0\%$ . During the study, unfavorable



total resistance (*FCU*) used for fuel estimation.

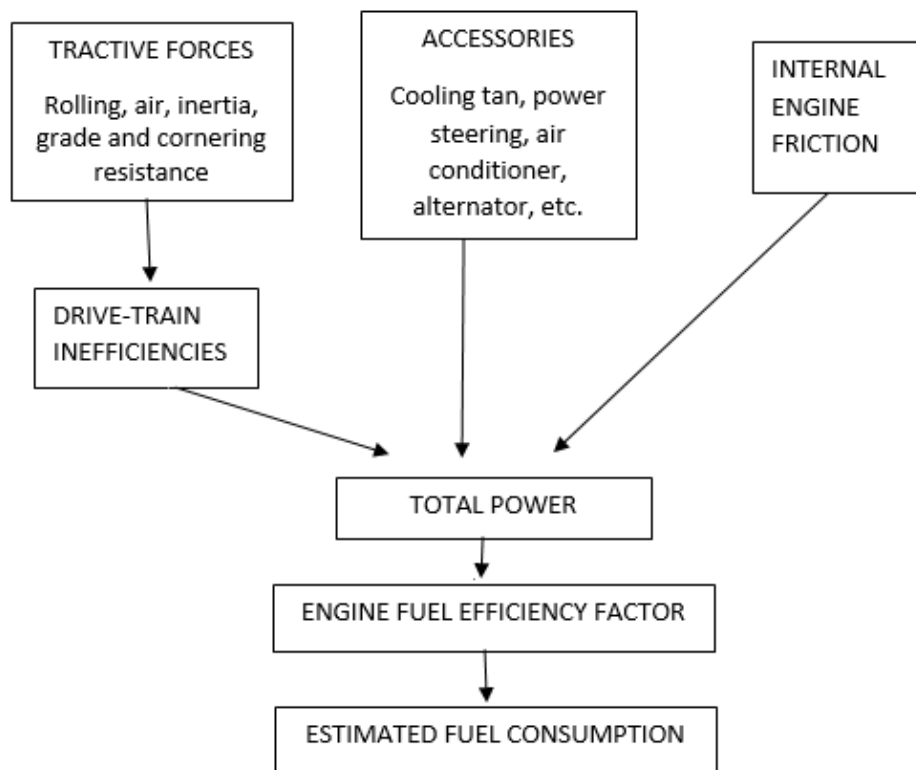
Driving behavior and type of engine (electric or mechanical) can also affect fuel consumption, and various models can be created to analyse. Increasing the speed of a vehicle, reduces its engine efficiency in the deflected road surfaces, while an increase in torque will increase engine productivity (Hammarström, 2012). Driving resistance occurs from driving behavior and road surface condition. A study showed that a 10% reduction in *RR* could reduce fuel consumption by 3% (Nielsen et al., 2002). For example, about 3,000,000 liters of fuel is consumed per day in the mining operations of Western Australia, and a 3% reduction can result in significant savings. The findings of a study by the Australian Roads Research Board (*ARRB*) in 2006 showed a 10 % change in *RR* could change the fuel consumption by 1-2%. Overall, a 4% change in *RR* could result in a 1% change in fuel consumption (Thompson, 2011).

Another model was proposed for modelling fuel consumption of heavy trucks (Du Plessis, 1990) as it is shown in Equation (2.10), General formulation for fuel consumption. In this equation: *F* is fuel consumption (ml/km), *G* is the road gradient, *P1*, *P3*, and *P4* are coefficients derived from the rolling resistance, air resistance, and grade resistance respectively, and *P2* is coefficient related to idling fuel consumption. Fuel consumption is directly related to the energy required to overcome resistance to motion. An increased roughness will increase rolling resistance, and lower tire pressure will also increase rolling resistance. According to these two results: An increase in road roughness causes an increase in tire temperature, which increases fuel consumption. An increase in road surface texture will also increase *RR* (Du Plessis, 1990).

$$F = P1 + \frac{P2}{V} + P3V^2 + P4G \quad (2.10)$$

The study by Tan et al., (2011) focused on the relationship between *RR* and fuel consumption,

where the results showed that: if the vehicle has a lower speed, the effects are lesser in the *VOC*. It means the lower cost is possible with a lower speed limit for earthmoving operations, and if *RDS* increases, fuel consumption will increase as well (Tan et al., 2011). Also, Greenwood et al. studied fuel consumption in 2003, where the target was the ability to predict fuel consumption as a function of engine input and output power, as shown in Figure 10. The final form of simplified input data and was adjustable for different vehicles (Greenwood et al., 2003).



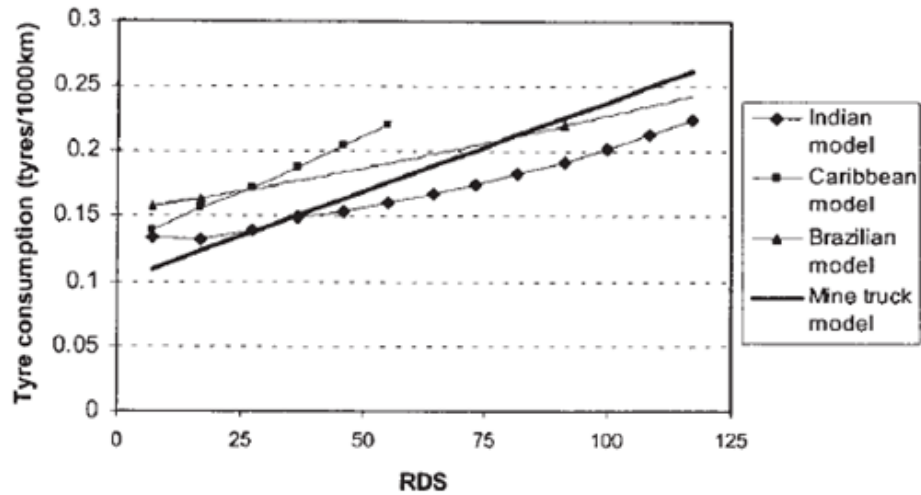
**Figure 10. A model for fuel consumption (Greenwood et al., 2003)**

Between *RR* and fuel consumption, there are some specific complexities in developing a relationship that is worth noting. Therefore, the models that were presented in this section provide an estimated fuel consumption in steady-state operating conditions. Another research by Chatti et al., (2012) presents an analysis of fuel consumption variation concerning changes in the

International Roughness Index (*IRI*) and texture (Mean Profile Deep-MPD) of the road. Roughness score and texture level have a greater effect on heavier trucks. However, the study was shown; texture and roughness have a lesser effect on fuel consumption at lower speeds (Chatti et al., 2012).

#### **2.4.2. Tire Cost Model**

Tire cost is one of the most significant costs in the mining and heavy civil engineering operations. Tires can account for 25% to 40% of the earthmoving operation costs at an open-pit mine (Thompson and Visser 2006). Tires are directly affected by the road surface condition because they are the only parts of a truck that is in contact with the road surface. Thus, the related research studies aim to find an optimum tire life and cost by examining the relationships between tire consumption and operational variables. Tires can be damaged by overloading, spillage, rock damage, and heat build-up. Two environmental factors are critical for the heat build-up: speed and load. According to Clark, principal energy losses can classify in three categories; friction between tire and road (2-10%), air resistance in and outside of tire (1.5-3.5%), and internal tire hysteresis (90-95%) (Clark, 1981). Therefore, the reduction of rolling resistance can increase the durability of a tire. Several tire cost models were created in different countries (Figure 11). The cost of tires is related to tire wear, which involves abrasive wear of the tire. As it is provided in Figure 11, all the models show a correlation between *RDS* and tire consumption (Thompson and Visser 2003), and higher *RDS* values result in accelerated tire consumption.



**Figure 11. Haul truck tire consumption model in comparison to other models (Thompson and Visser, 2003)**

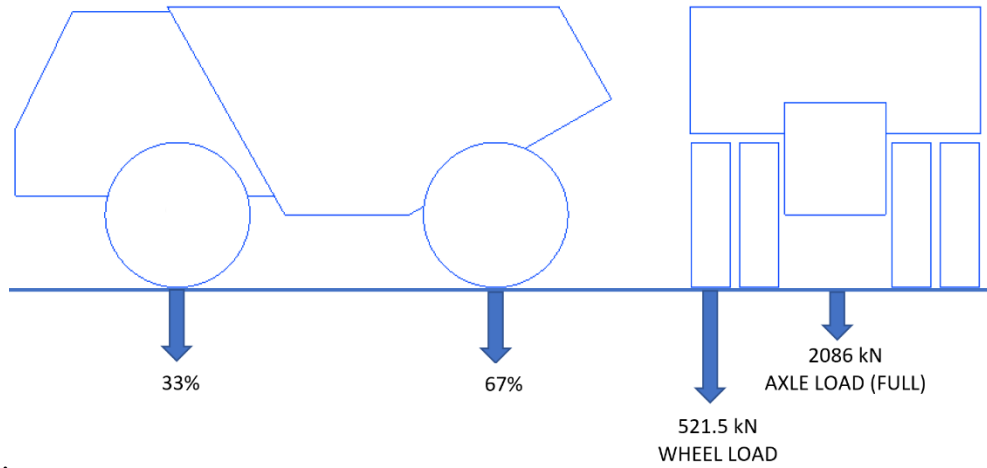
As it is shown in Equation (2.11), a model of tire consumption based on *RDS* and grade resistance (*GR*) as the main variables (Thompson and Visser 2003) can be defined as:

$$TW = 0.098 + 0.0015RDS + 0.002IGRI \quad (2.11)$$

Good pavement structure design should be able to carry the imposed load with minimum maintenance or rehabilitation. Truckload distribution is an important factor, as the load is heavier in the rear section of dump trucks. For example, Caterpillar 789 has a capacity of 170 tones, but its Gross Vehicle Mass (*GVM*) is almost 320 tones, and around 67 % load sits on the rear tires, and therefore the rear side of the truck has dual tires (see Figure 12 by Thompson and Visser (1997)). Another proposed equation for tire wear includes tire cost under different pavement conditions and management systems, as shown in Equation (2.12). Based on this model, tire consumption depends on roughness score and *GVM*. The results of this model are close to the outcomes of Equation (2.11) (Adedimila et al., 2009).

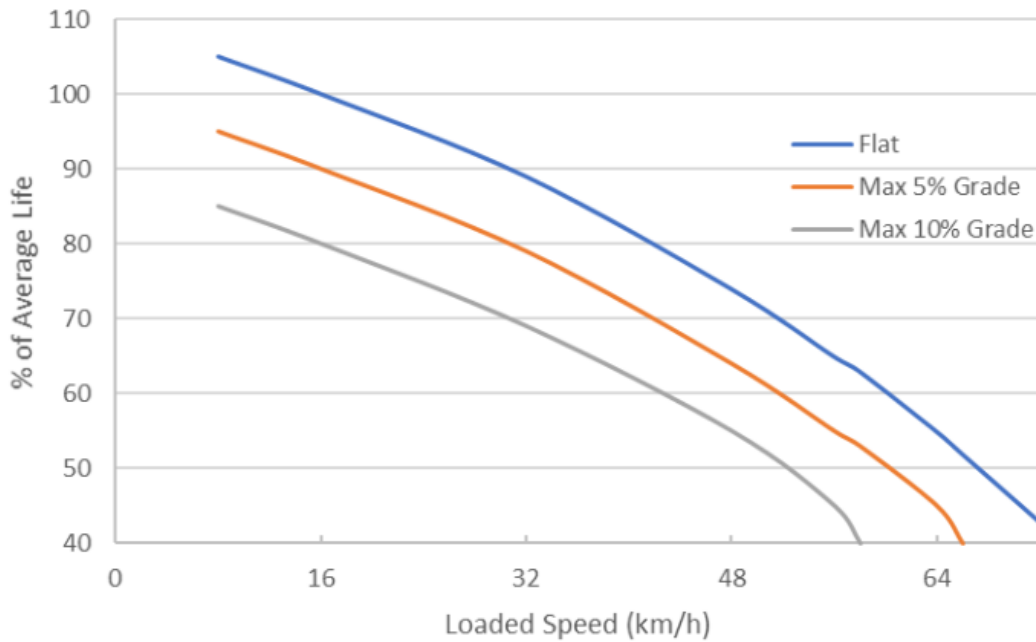
$$TCB = \left( \frac{0.1504 + 0.19215e^z}{1 + e^z} \right) * GVW * 10^{-4} \quad (2.12)$$

$$z = -4.302 + 0.00737R$$



**Figure 12. Load distribution in an off-highway dump truck based on Thompson and Visser 1997**

Another research effort studied the life of tire based on the grade of the road and speed of the truck. Based on the findings of this study, if the grade percentage and speed increase, the life of tire will decrease dramatically (Figure 13) (Woodman and Cutler, 2002).



**Figure 13. Reduction in tire life (Woodman and Cutler, 2002)**

Speed is an important factor in the useful life of truck tires because speeding can accelerate deterioration process of the tires through higher heat generation inside the tire, rapid braking, sharp cornering, road debris, and collisions on the road (Woodman and Cutler, 2002). Higher speeds also increase tire sinking, which accelerates energy consumption due to higher rolling resistance. Based on a case study, a set of speed limits for different earthmoving equipment was proposed (samples are shown in Table 4).

**Table 4. Typical vehicle speed limits (Woodman and Cutler, 2002)**

<b>Type of Vehicle</b>	<b>Maximum Speed</b>
Earthmover	65 km/h
Scraper	48 km/h
Grader	40 km/h
Loader & Dozer	10 km/h

### **2.4.3. Tire Inflation (Tire Response)**

Higher temperatures create stress and deformation in tires. Since there is no contact between tire rubber treads and wheel's rim, thus the way that the energy can be lost as heat. If the weather temperature increases, the tire temperature will increase as well. Operating at high-temperatures means high-energy consumption for the vehicles. Heat can cause hysteresis (strain-stress) in the rubber and increase friction between tire and road surface. The highest temperatures occur in the front of the contact patch and heat the tire steel belts, which increases stiffness, and it can cause bulging besides the contact patch sidewall and increases the energy consumption of trucks (Li et al., 2012). When the weather temperature is 40 °C, the tire temperature will be about 88.5 °C, which is slightly lower than the maximum tire level-off temperature (93 °C). As results, hot

weather and higher speeds accelerate tire temperature. Therefore, it increases VOC. The research intends to reduce tire temperature to save energy, which is possible with low speeds.

In recent years, tire technology has been changed; for example, the energy losses from rolling resistance have been reduced by almost 70% with the coast-down test method. Moreover, over or under inflation will increase energy loss because the pressure will be distributed non-uniformly within the tire. The tire's contact area with the ground will be decreased by 50% and 60% of a properly inflated tire in over- and under-inflated situations respectively. Optimum inflation will result in about 100% contact area with the ground, which is an effective way to overcome rolling resistance (Nielsen et al., 2002).

Over or under inflated tires increase fuel consumption, because load distribution is not uniform (unlike the proper inflation). Over and under-inflated tires waste energy due to stress/strain (hysteresis) response of the road surface. Pavement stiffness and optimally inflated tires are essential factors for controlling static rolling resistance coefficient, and better road pavement designs can be developed a better rolling resistance modelling (Delcaro et al., 2001).

## **2.5. Operational Mistakes**

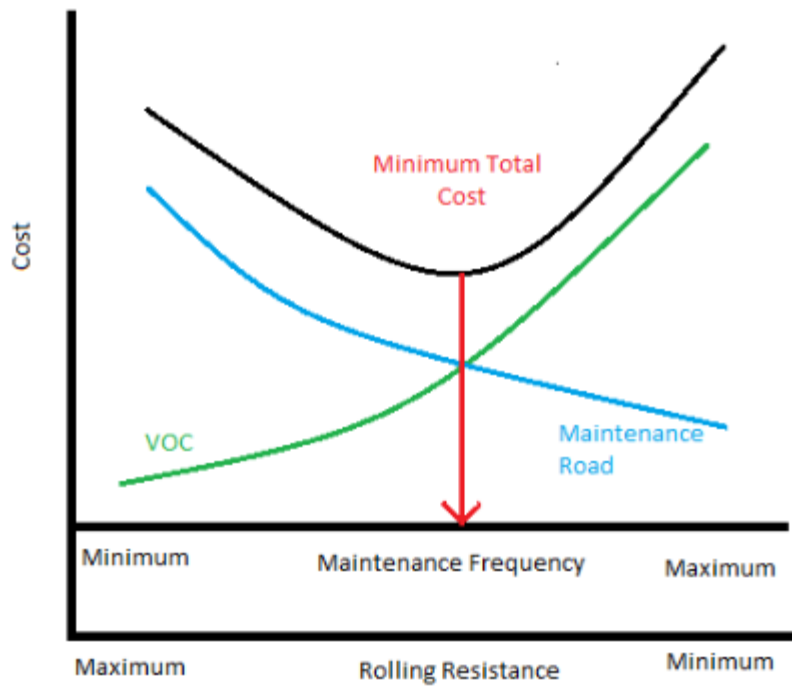
Operational mistakes can classify into two classes: mistakes by loader operator and the mistakes by the truck driver. Loader operator might not have a clear view of the operation, which can cause overfilling or missing the truck' tray, which results in overloading and spillage. Spillages can increase the risk of rock impact damage, rock cutting, and penetration. Based on the findings of a study, up to 70% of tire damage could occur in the loading or dumping areas. Therefore, maintaining and clearing the loading and dumping areas is an important daily task. (Woodman and

Cutler, 2002).

## **2.6. Maintenance Management Strategy (*MMS*)**

Application of proper road maintenance management strategies (*MMS*) has the potential to reduce *VOC*. Optimization of maintenance schedules includes determining the most suitable maintenance type and frequency, which aims at minimizing both *VOC* and road maintenance costs. *MMS* models can provide various improvement with the potential to generate significant cost benefits (Thompson and Visser 2000). There are many interdependent parameters to assess the unpaved road conditions such as gravel loss, rutting, potholes, corrugation, drainage conditions and, traffic volume (Torres-Machi et al., 2014). Figure 14 illustrates the relationship between rolling resistance, *VOC*, and maintenance cost. Based on this figure, maintenance frequency and road maintenance costs are inversely associated with rolling resistance value and *VOC*. The converse is true, where if the road maintenance costs are minimized, rolling resistance and *VOC* will increase. (Thompson and Visser 2003).



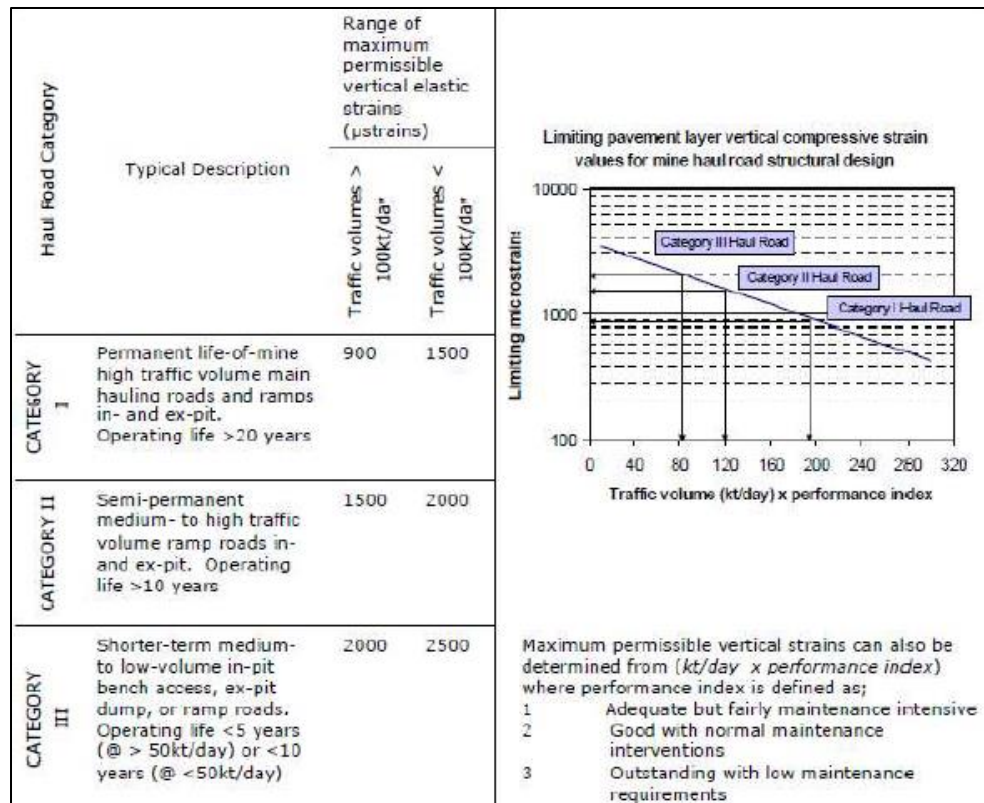


**Figure 14. Minimum total cost solution based on road maintenance frequency and vehicle operating costs (VOC) (Thompson and Visser, 2003)**

Thompson (2011) developed a classification method to evaluate haul road conditions using traffic volumes. This method serves to indicate operating intensities and maintenance requirements. Figure 15 provides details about pavement strain theory related to operational intensity and maintenance requirements. Three categories were defined as (Thompson, 2011):

1. Adequate but fairly maintenance intensive.
2. Good with normal maintenance interventions.
3. Outstanding with low maintenance requirements.

The method was refined for haul roads through observations of operational road surfaces. A benefit of this model is that it can estimate maintenance cost based on pavement design.



**Figure 15. Pavement strain theory related to operational intensity and maintenance requirements (Thompson, 2011)**

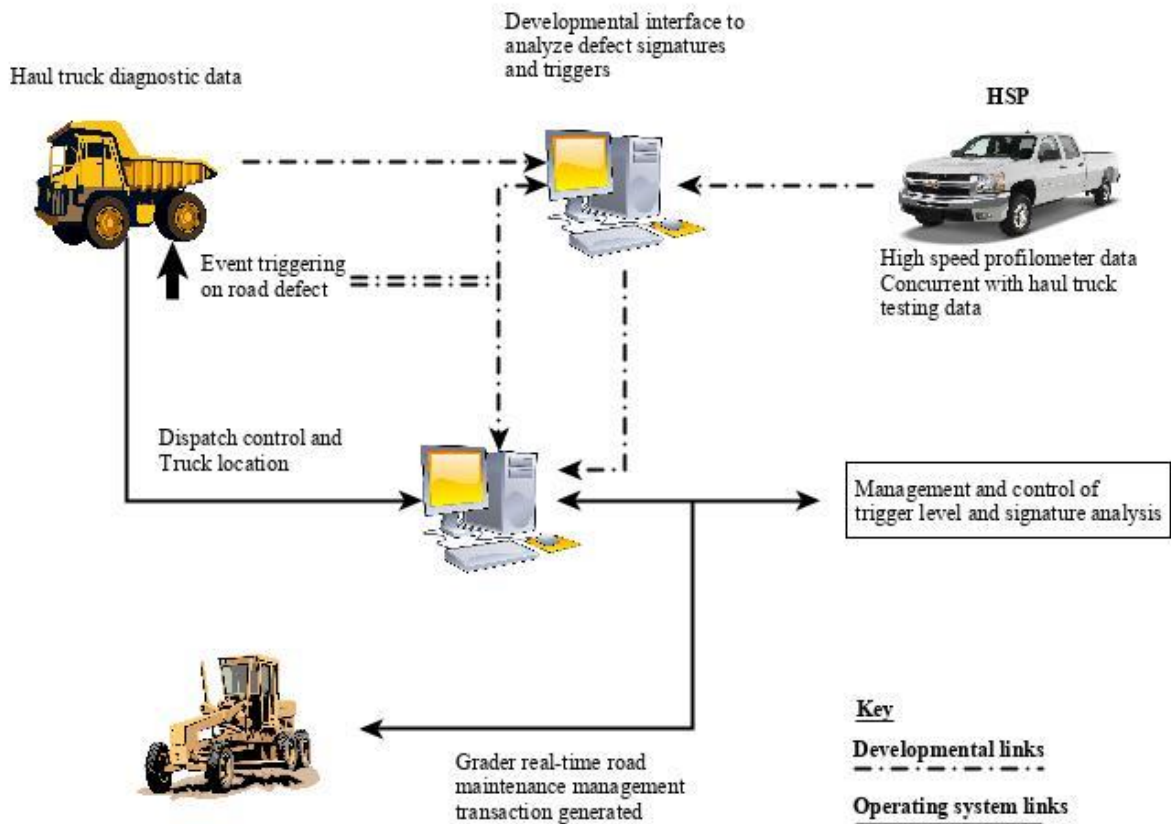
Maintenance activities include routine maintenance, resurfacing, rehabilitation, and betterment. A study by Thompson suggests four types of maintenance for haulage roads (Thompson and Visser, 2003):

1. Ad hoc blading: Maintenance based on daily inspection.
2. Schedule blading: Maintenance service is generated based on a fixed schedule or frequency.
3. Maintenance Management System: the rate of deterioration of an individual roadway segment is determined based on roughness progression.
4. Real-time road maintenance: The truck fleet can determine vehicle response to road

functionality, both regarding rolling resistance and individual roughness defects.

The real-time road maintenance method is the most recent approach for earthmoving operations. The first step of this method is to sense road surface condition by the truck fleet. It requires an integrated truck monitoring system to collect data from the road condition. Data is typically collected using *GPS*, active *RFID*, or other types of sensors. Then the acquired data are transferred for analysis to computers, which will indicate whether maintenance interventions are required or not. This process is conducted in real-time, which allows for the identification of road defects in a relatively short time frame (Thompson and Visser, 2006). Figure 16 illustrates this process.

As trucks travel along haulage roads, various metrics such as vertical road deflections are identified and located using *GPS*. One of the research efforts to study *GPS* to measure road deflection was carried out by Hugo et al. (2008). According to this study, *GPS* units were placed in the front of vehicle wheels' sprung mass, as well as at the left and right front tires to detect the defects of haul roads.



**Figure 16. Integration of a real-time CTM system with existing mine communication and asset management systems (Thompson and Visser, 2006)**

### 2.6.1. Vehicle Maintenance Cost Models

Vehicle maintenance and repair costs comprise the cost of the parts consumed and the labor hours required for repair and maintenance of the equipment. There are several interdependent parameters for vehicle maintenance cost, which include the type and age of the equipment, driver behavior, and road surface condition. Figure 17 displays different models of the vehicle part cost developed in different countries and as the roughness defect score increase, parts cost will increase as well (Thompson and Visser 2003).

Equation (2.13) shows a mathematical model developed for the costs of parts and labor. This

equation shows that the ratio of part costs (P) to the replacement costs (VP) depends on vehicle age (H) and the RDS. Vehicle age is based on the number of operational hours of the equipment (Thompson and Visser 2003).

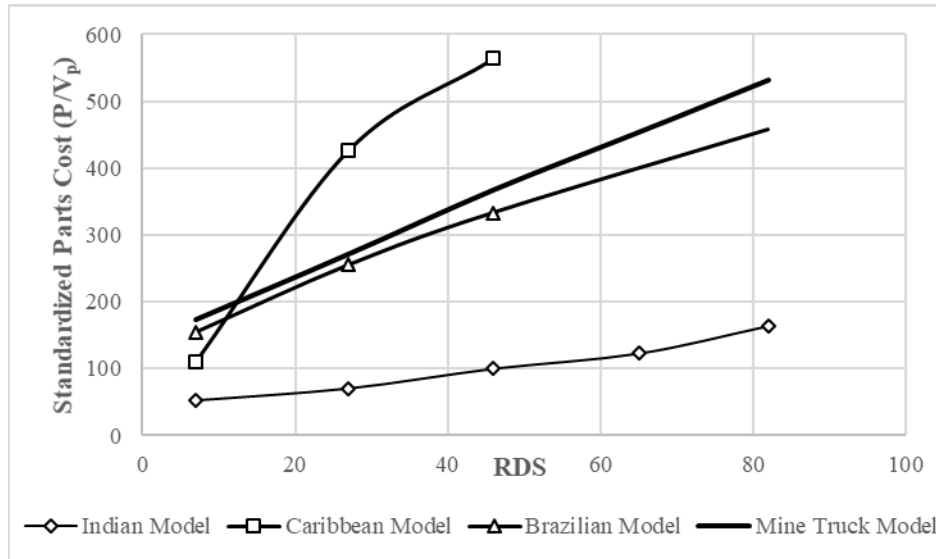


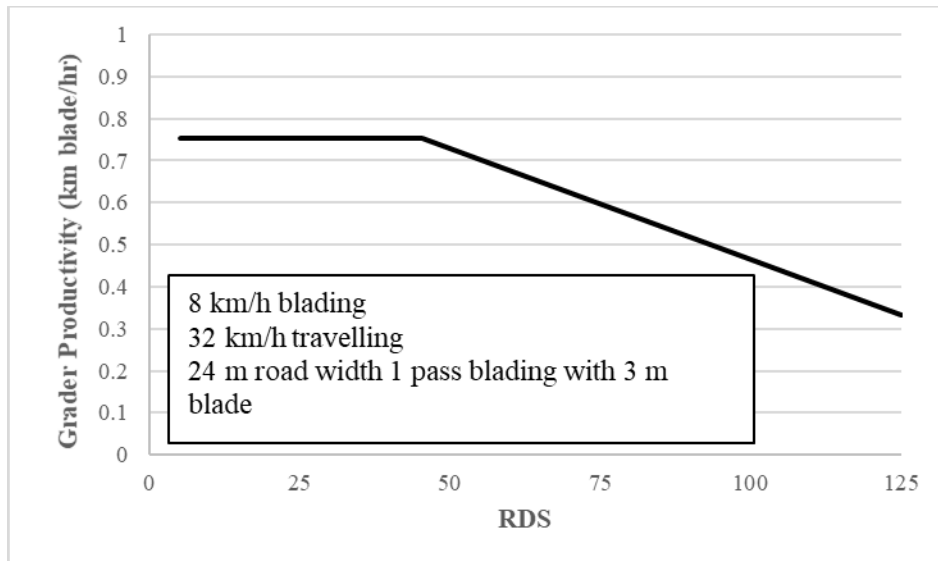
Figure 17. Comparison of different haul truck parts cost models (Thompson and Visser, 2003)

$$\frac{P}{VP} = (67.28 + 2.31 \cdot RDS) H^{0.375} \quad (2.13)$$

### 2.6.2. Road Maintenance Cost Model

When maintenance costs are integrated into a road maintenance cost model, costs should be identified as the lowest overall vehicle and road maintenance costs for optimal maintenance strategy in the earthmoving operations. The road maintenance service involves repairing potholes, reducing erosion and material loss, reshaping road surfaces and maintaining roadway geometric properties such as crowns, superelevations or surface itself. Maintenance operating costs are estimated based on a per-kilometre rate. Grader and water truck operating costs are the most significant parameters for maintenance cost (Dekker, 1996). Water truck is necessary immediately before and after blading of the motor grader for watering, because it reduces dust, erosion, and

material loss. Thompson and Visser (2006) showed that when the haulage road surface has higher rolling resistance (i.e., a higher *RDS*), the productivity of the maintenance task by a motor grader will decrease, as shown in Figure 18. Road maintenance cost is estimated by considering average blade width per pass, road width, *RDS* before blading, motor-grader productivity curve, and hourly cost of motor-grader operation. This cost is subsequently combined with the cost per kilometer of the water truck to produce a total cost per kilometer for road maintenance (Thompson and Visser 2006).



**Figure 18. The productivity of a motor grader during routine haul road maintenance operations (Thompson and Visser 2006)**

The objective of the road maintenance is to provide a standard haulage road surface profile, as shown in Figure 19, Proper haulage road surfaces should provide adequate drainage from the center of the road surface. The geometric design is important because it has the potential to decrease *VOC* (Thompson and Visser, 2007).

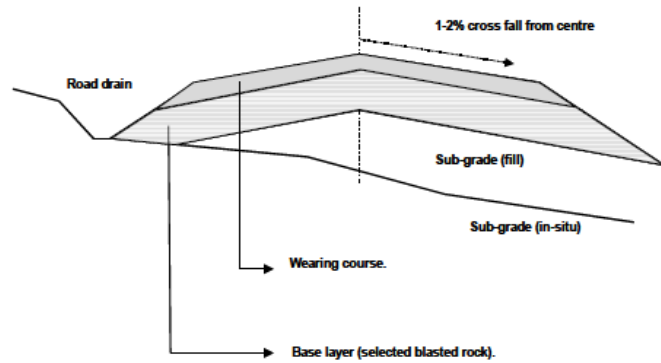


Figure 19. Typical haul road design components (Thompson and Visser, 2007)

## 2.7. Dust Effects

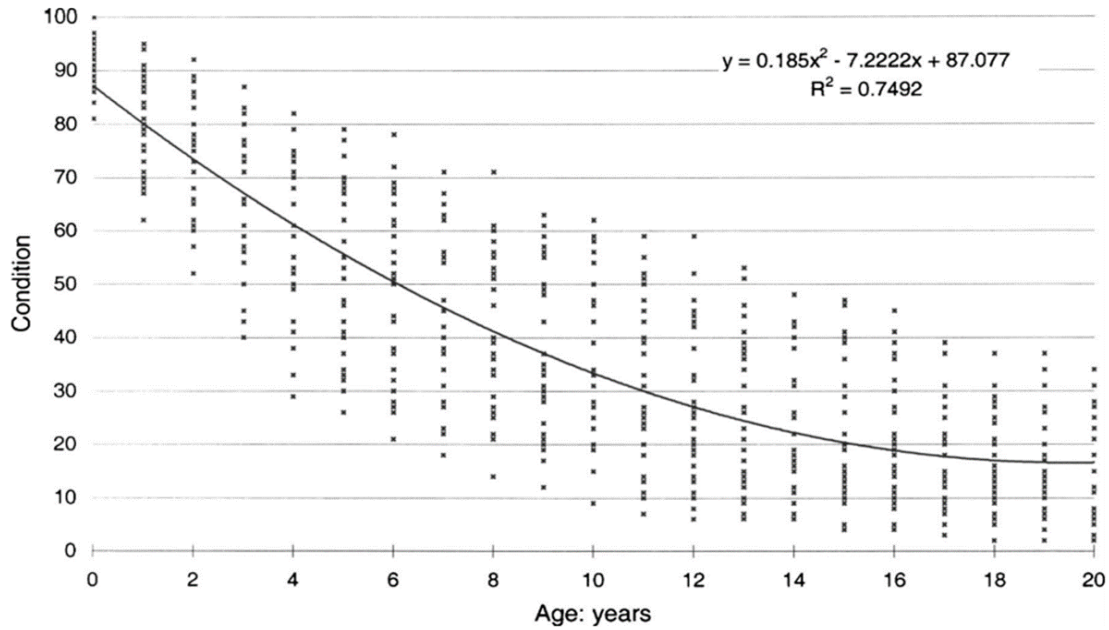
Dust generation is an important problem for haulage road defects because it is caused by loose roadway materials such as fine aggregates or eroded by-products, subjected to wheel movement or local wind turbulence. The loss in roadway material is associated with defective haulage road surfaces. A proper wearing course layer requires a mix of different size aggregates, including coarse and fine aggregates, and fines. Dust is composed of small fines, and if these fines leave the mix, aggregate will lose its integrity. Dust generation can be mitigated through suppression, palliative treatments, or water-based spraying (Pye, 1995). Every earthmoving operation job site has a different degree of allowable dust defect score, which is determined based on the location. The classifications of the degree of haul road dust defect, based on the table dust defect degree 1 is the best case, and degree 5 is the worst case. Dust defect degree limits determine the choice of palliation types, such as water or chemical, and frequency of treatment (Thompson and Visser 2007).

## 2.8. Using a Markov Model for Maintenance of Unpaved Roads

Most of the proposed methods were based on deterministic modelling. Road deterioration can also be modelled using discrete-time Markov models. In this approach, pavement condition states can be defined. The most important parameters are the state transition probabilities, which are estimated considering the effects of deterioration and maintenance actions (Gao and Zhang, 2013). The transition probabilities of a Markov chain are represented as a matrix. Markov process is any stochastic (random) process that satisfies the Markov property. The future state of the system depends only on the current state of the system, not on the former states. Because of this property, Markov models are typically referred to as memoryless, as they have no memory of the past states. Markov models have become an increasingly popular topic in the last few decades to model infrastructure condition, as the maintenance operations have become increasingly important in the past decades. (Dekker, 1996). Markov modelling is useful for forecasting the future condition of civil structures such as road and sewer systems.

Moreover, Markov modelling has been used for optimal maintenance of deteriorated systems with the pavement performance prediction model (Worm and Van Harten, 1996). This study focuses on road deterioration according to the Markov-based model to minimize both maintenance cost and VOC (Smilowitz and Madanat, 2000). Figure 20 illustrates the prediction of pavement condition index in 20 years. Thus, based on the condition, index maintenance will generate service. When an *MMS* generates maintenance works more frequently, the life-cycle maintenance costs will increase while the life-cycle *VOC* will decrease (Ortiz-García et al., 2006).





**Figure 20. Prediction of pavement condition based on its age (Ortiz-Garcia et al., 2006)**

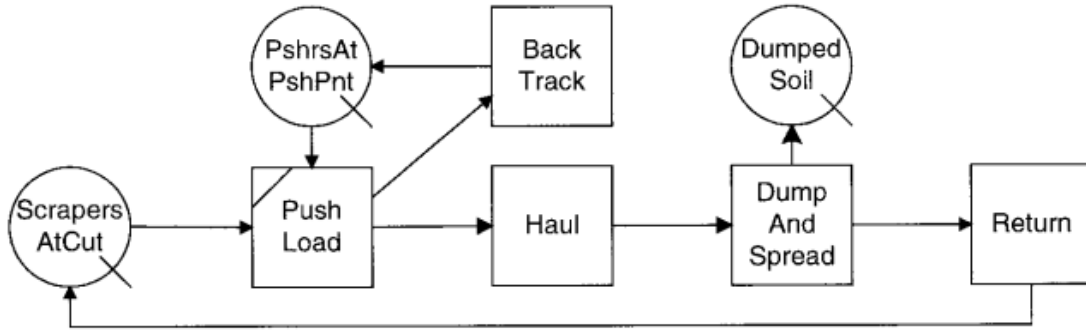
Furthermore, poor haulage roads have reduced road service times due to the presence of work zones. Therefore, it is an important function to prevent road defects. Goh et al. (2012) examined *VOC* perceptions through a questionnaire survey of stakeholders of highway projects in Australia (Goh et al., 2012). The results indicate two significant components: crash costs and the *VOC* with travel delay costs. Although the definitions of cost components may differ across countries while determining an optimal road maintenance schedule, a method to develop a model about road deterioration process with discrete-time Markov modelling should be used. A (discrete-time) Markov chain is a special type of Markov process. The process consists of a sequence of random variables such as  $X_1, X_2, X_3 \dots$ . The model performs a life-cycle cost analysis based on the Markov Decision Process (MDP), which can calculate total life-cycle costs over the service life of the road (Golabi et al., 1982).

Previous studies are generally based on the continuous-time Markov process. Semi-Markov Process has also been developed to model the road deterioration process more accurately. However,

these models have complex solutions regarding data collection and often require a small road network to be involved. Thus, the Markov Decision Process model based on the discrete-time Markov process is more practical to be used for current maintenance practices (Lee and Madanat, 2015).

## **2.9. Role of Simulation in Heavy Construction and Mining Industry**

Construction simulation is the application of computer-based systems to model construction operations which help understand their logic and behavior. Simulation methods can provide an overview of the long-term and cyclic operations, which helps to produce more accurate results (AbouRizk, 2010). When construction projects are longer and more complex, it will be more difficult to manage them with traditional methods, and computer simulation methods are useful to analyse such problems. There are several construction simulation systems, including CYCLONE (The Cyclic Operations Network) and Symphony.Net. CYCLONE involves a wide range of tools. It is a common, easy to use and comprehensive software for simulation modelling. The conditions necessary for activities to start are often the outcomes of other activities. This type of network called an activity cycle diagram (ACD) (Martinez and Ioannou, 1999). A sample ACD in cyclone environment is shown in Figure 21. The figure shows different types of tools, and every tool can have its coding or equations.



**Figure 21. A graphical view of the model of an earthmoving operation in CYCLONE (Martinez and Ioannou, 1999)**

Cyclone methodology was used in various academic and research studies during the last decades; however, in the real-life construction, companies do not utilize the simulation method in everyday decision-making (AbouRizk S., 2010). How can the method be implemented easily to construction firms? According to AbouRizk (2010), implementation can be applied to construction firms in three different ways, which are: dynamic process interaction, continuous time-dependent, and static simulation. The main goal of simulation in construction firms is to develop an efficient process for productive construction (AbouRizk and Hajjar 1998). There are approximately 20 forms of software products for construction simulation. Through an effective application of simulation in construction operations, productivity could be increased by 30% to 200% (Halpin and Martinet, 1999), which could be achieved by modifying operations or improved resource allocation.

Mining and heavy construction projects such as dams and highway construction require different equipment, plants, and methods of construction. However, in practical cases, there are different scenarios and conditions and resource allocation should be optimal, which is possible through simulation. Simulation can make analytical and decision-making models more accurate. Various scenarios can be tested to overcome these problems. The primary goal is to achieve decreasing costs and duration of projects and how operations can be implemented in a different type of

projects (Vanegas et al., 1993). Nowadays, there are issues with integrating the simulation to object-oriented principles.

Furthermore, there are knowledge gaps between the user and the simulation software. New approaches to simulation have additional functionality and usability. For example, Symphony.Net is a visual simulation software with programming ability and, special purpose simulation modelling functions (Hajjar and AbouRizk, 2002). When analysing the results of individual mining or heavy civil engineering earthmoving operation simulations, the actual mine operating practice was seen to closely similar that predicted by the model, especially about increased maintenance intervals on haulage roads.

## Chapter 3: Methodology

This chapter explains the proposed methods to model the deterioration of unpaved roads under operation in mining and heavy civil engineering fields and discusses the implementation of different maintenance frequencies. Maintenance cost and vehicle operating cost (*VOC*), which includes fuel, tire, and parts consumptions, were defined as two main variables to optimise. The mentioned variables were analysed using the proposed methods to estimate the optimal maintenance frequency. These two variables are directly related to road surface conditions. Road surface condition represents the rolling resistance (*RR*); if *RR* increases, the trucks' performance and efficiency will decrease (Thompson and Visser 2003). *RR* modelling can be implemented using Roughness Deflect Score (*RDS*), which is a numerical index and describes the haulage road conditions. This chapter provides the equations, simulation codes, and steps for deterministic and dynamic modelling, which include stochastic and Markov models.

The performance of *VOC* and unpaved road parameters depend on road structure, such as California Bearing Ratio (*CBR*), Plasticity Index (*PI*), and operational characteristics, including traffic volume, truck speed, and truckload. Therefore, it is important to consider all related parameters in the estimation of *VOC*. Mining and heavy construction operations are costly. Therefore, preventive measures are necessary to reduce *VOC* and *MMS* cost, and optimal maintenance frequency plan is an effective approach (Thompson and Visser 2006).

The first step is to select an appropriate method to model the relationship between *RDS* and *RR* for haulage roads. Rolling resistance occurs as soon as the truck tires start to roll, which can be generated by friction and flexing between tire and road surface, and it does not remain constant due to varying conditions, such as weather, load, or speed of the truck. It is possible to define a

practical model for optimal energy consumption based on some basic parameters, which enables practitioners to use a few models for comparing the results. The following modelling approaches were studied in this research:

1. Deterministic Modelling
2. Stochastic Modelling
3. Markov Chain Modelling (Dynamic Modelling)

### 3.1. Deterministic Modelling

Deterministic models use a set of equations and constant variables, and different runs with the same input data will provide the same results. However, it is unrealistic to get the same results in real-world cases, because the input data, such as load and speed of trucks, are usually random, which follow a probabilistic distribution. The relationship between  $RR$  and  $RDS$  is essential because  $RDS$  will affect  $RR$ , and  $RR$  is a critical parameter to calculate  $VOC$  and maintenance costs. In the deterministic modelling, the value of  $RR$  will have constant values, which means that the model always provides a fix constant output. Thompson and Visser (2003) proposed the following relation between  $RR$  and  $RDS$ :

$$RR = RRMIN + RDS * exp^{(f)} \quad (3.1)$$

Where the unit of  $RR$  is N/kg.  $RRMIN$  is the minimum rolling resistance which exists when the  $RDS$  score is zero (ideal road surface condition after construction).  $(f)$  is a regression function which is used to estimate the rate of change of  $RR$  ( $LDRRI$ ).  $RRMIN$  and  $LDRRI$  can be defined as (Thompson and Visser, 2003):

$$RRMIN = \exp^{(-1.8166+0.0028 * V)} \quad (3.2)$$

$$LDRRI = 6.068 - 0.00385RDS + 0.0061 * V \quad (3.3)$$

According to equation (3.1), *RRMIN*, the regression function, and *RDS* affect *RR*. In general, deterioration of *RR* depends on the increase of *RDS* and trucks' average speed (*V* in km/h). Therefore, the average speed is important for *RRMIN* and *LDRRI*, where higher speeds can accelerate the deterioration of the road surface. Equation (3.1) explains all the parameters except *RDS*. A model was proposed for *RDS* progression, which is provided in Equation (3.4) (Thompson and Visser, 2003):

$$RDS = RDSMIN + \left[ \frac{RDSMAX - RDSMIN}{1 + \exp^{(D*f)}} \right] \quad (3.4)$$

Where *RDSMIN* is the minimum roughness defect score at time *D* = 0 (right after construction or maintenance) and *D* represents the number of days since the last maintenance. Therefore, road defect condition theoretically has the minimum value (*RDSMIN*) after road maintenance. *RDSMAX* is the maximum defect score of the road surface, *f* is a regression function which represents the rate of change of *RDS* (*LDRDI*). *LDRDI* depends on several parameters, including soil characteristics and operation, which are shown below (Thompson and Visser, 2003):

$$LDRDI = 1.78 + 0.001 * D * (2.69 * KT - 72.75 * PI - 2.59 * CBR - 9.35 * GC + 1.67 * SP) \quad (3.5)$$

Where,

D: days since last maintenance,

KT: average daily tonnage hauled,

PI: plasticity index,

CBR: California bearing ratio,

GC: grading coefficient, and

SP: shrinkage product.

Therefore, it is necessary to estimate  $RDS_{MIN}$  and  $RDS_{MAX}$  values to determine RDS. Equations (3.6) and (3.7) define the  $RDS_{MIN}$  and  $RDS_{MAX}$  functions as follows (Thompson and Visser, 2003):

$$RDS_{MIN} = 31.1919 - 0.05354 * SP - 0.0152 * CBR \quad (3.6)$$

$$RDS_{MAX} = 7.6415 + 0.4214 * KT + 0.3133 * GC + 0.4952 * RDS_{MIN} \quad (3.7)$$

During this study, some primary data (e.g., soil parameters) should be assumed or collected from the literature. Then given the RR and RDS, fuel, tire, and parts consumptions could be estimated. The research methodology provides the relationships between RDS and VOC, including fuel consumption, tires, and spare parts.

### 3.1.1. Fuel Consumption

Fuel consumption varies with the road defect score; if  $RDS$  increases, fuel consumption will increase as well, because the truck's engine must overcome a greater total resistance. For the numerical experiments, the 777 D caterpillar truck model was chosen as it is a common off-road dump truck used in heavy earthmoving operations. The body type of 777 D is a dual slope, the



gross machine weight (*GMW*) is 163 tones, and its payload limit is 96 tones. The net power of this type of dump truck is 699 kW, its gross power is 746 kW, and has a top speed (Loaded) of 60.4 km/h. These heavy trucks can cause accelerated deterioration on the haulage road surfaces. The proposed model for fuel consumption considers total resistance (*TR*) as an unfavorable factor, which is shown in equation 3.8. *TR* unfavorable is applied when  $TR \geq 0$  %. *TR* is equal to *RR* plus grade resistance (*GR*). Speed and load also have an important role in fuel consumption equation (Thompson and Visser, 2003).

$$FCU = 1.02 + [UVM * V(296 * TRU + 4.5 * V) + L * GVM * V(246 * TRU + 0.0027V^2)] * 10^{-5} \quad (3.8)$$

Where,

*UVM*: unladen vehicle mass (tons),

*V*: speed (km/h),

*TR*: total resistance (*RR+GR*),

*L*: loaded truck indicator variable (1 if loaded, 0 otherwise), and

*GVM*: gross vehicle mass (tons).

A critical point in the fuel consumption equation is that a truck will consume different amounts of fuel when it is loaded or unloaded, as it consumes much more fuel when it is loaded. *L* is a binary variable in equation (3.8), in which one means that the truck is laden and zero means that the truck is unladen. Therefore, fuel consumption equation should be used twice for each cycle: the first time is for the hauling segment, and the second time is for the returning trip of trucks.

During the fuel estimation process, deterministic modelling uses constant values for the main parameters, such as speed and a load of trucks. For example, if speed is assumed at 40 km/h, the model considers that all the trucks move at 40 km/h from the start to the end of a hauling cycle, which is not realistic in practice. A numerical model was created for the modelling, which included 20 trucks, and each truck operated 20 cycles per day, and fuel cost was assumed at 1.2 CAD per litre. Truck weight and speed were set according to the basic data. In this approach,  $RR$  should be firstly calculated using Equation (3.1). Then, fuel consumption could be calculated according to equation (3.8). Unit of fuel consumption is ml/sec but could be converted to km/litre (by using the average speed).

### 3.1.2. Tire Wear Estimation

Tires are among the most expensive items in earthmoving operations because they are the only part of the truck in direct contact with the road surface and considerable amount of stress and strains are transferred and sustained by the tires. Moreover, tires are the most expensive maintenance element (Thompson and Visser, 2003) in the maintenance cost of equipment. Therefore, an effective MMS objective is to slow down tire wear instead of repairing. Equation 3.9 is used here to estimate tire wear in numerical modelling. Tire costs are related to tire wear, which involves both abrasive wears of the tire treads and weakening of the tire carcass (Thompson and Visser, 2003).

$$TW = 0.098 + 0.0015 * RDS + 0.0021|GR| \quad (3.9)$$

In equation (3.9),  $TW$  is tire wear and represents the number of tires used per 1000km.  $TW$  is a function of  $RDS$  and grade resistance ( $GR$ ). Ground slope direction, up- or down-slope, is not important for the percentage of tire wear and the equation uses absolute  $GR$  value of the road as a

percentage (%). Tires sustain the same damage in both up and downslope, as the grade resistance is transferred to the tires in both directions. *RDS* values can be calculated by using Equation (3.4).

### 3.1.3. Parts Consumption

Part cost is significant for heavy construction and mining operations. Parts consumption could be controlled with proper and proactive *MMS*. Therefore, the relationship between parts consumption and road surface condition should be established, because while the haulage road surface is deteriorating, parts consumption will increase (Thompson and Visser, 2003). Equation 3.10 describes the relationship between parts cost and unpaved road surface. Based on this equation, parts cost depends on *RDS* value, vehicle age, and the replacement cost of parts. Vehicle age and replacement cost values can be obtained through market research, and part cost can be defined via Equation (3.10) (Thompson and Visser, 2003).

$$\frac{P}{VP} = (67.28 + 2.31 * RDS)H^{0.375} \quad (3.10)$$

Where,

*P*: parts cost,

*VP*: replacement cost of parts, and

*H*: vehicle age as an operating hour.

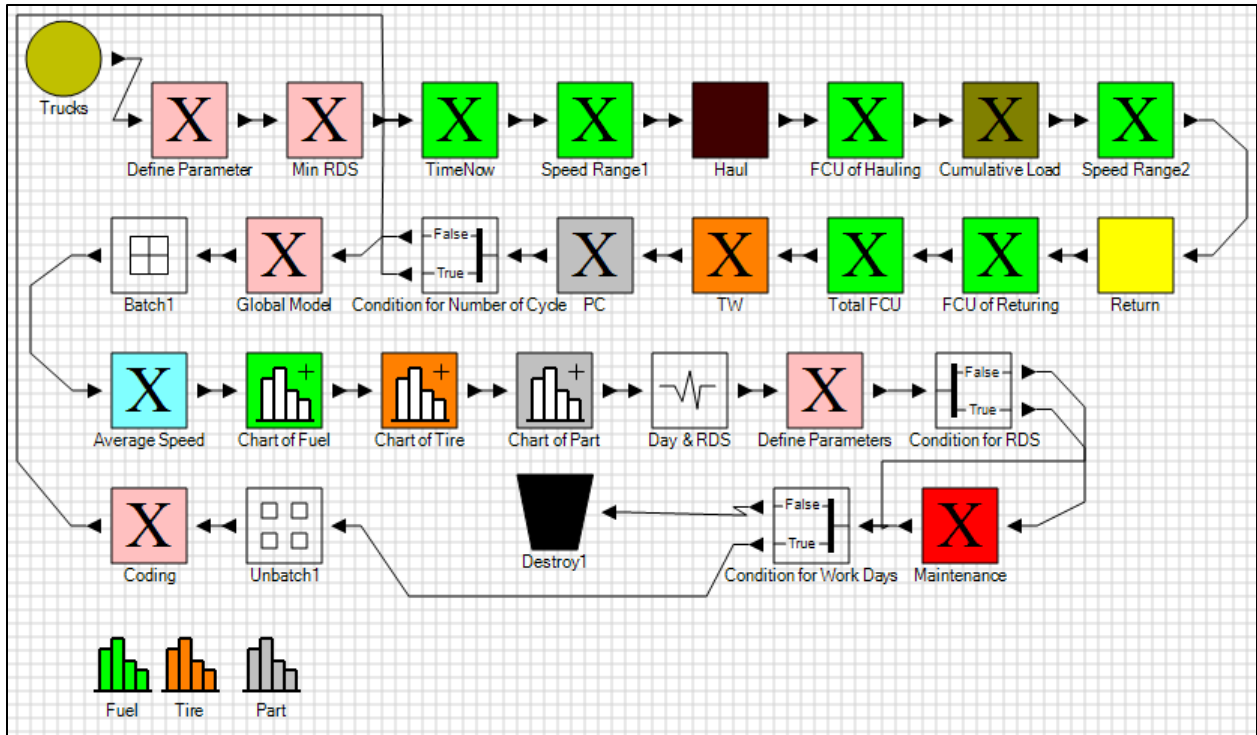
In the above section, three main consumption equations were introduced for the first step of the numerical modelling, and all these equations include *RDS* value as the main factor. If *RDS* is improved (through maintenance), *VOC* will decrease. However, these three equations produce constant values under deterministic modelling; which does not incorporate possible variations and

do not reflect the randomness in real situations.

### **3.2. Monte Carlo Stochastic Modeling**

Discrete-event simulation is a stochastic modelling approach that incorporates random variables, which follow a certain probability distribution, and this approach could be useful to obtain more realistic results. According to the literature, the productivity of construction management could increase between 30 to 200% by applying proper simulations (Halpin and Martinet, 1999).

This section explains a discrete-event-simulation (*DES*) approach to simulate road deterioration and to model *VOC* and maintenance cost. While simulating a model, variable values change in every run by sampling a random value from a probability distribution representing that variable. The stochastic simulation should be run several times. There are several software products developed for simulation in different domains. Symphony.NET 4.6 application was used for stochastic modelling in this study (<http://development.construction.ualberta.ca/downloads/>). Speed and load of trucks are random variables in this system, which are expressed in the form of a probability distribution, and the results of the simulation will vary based on the number of runs. The simulation model requires all the necessary basic data and equations to simulate the operation as the day progresses. Figure 22 shows a graphical representation of the stochastic model developed in the Symphony.NET 4.6 environment. This simulation platform includes all the main distribution types. During this study, the uniform and normal distributions were used.



**Figure 22. Stochastic model for VOC and maintenance in Simphony.Net 4.6**


During the stochastic and dynamic modelling, all the required data were coded (using Visual Basic language) as variables in the Simphony.NET 4.6. The coded variables track specified data based on the model requirements. The system can track two types of variables: local variables (type “L”), and global variables (type “G”). Type “L” is called local attributes because each entity has its own individual set of attributes. If the model needs to track the certain type of data for each entity (e.g. for each truck), a local variable is used, such as the load or fuel consumption of each truck. However, global variables are used to track certain data in the entire model, such as the total load carried or the total fuel consumption of all trucks. Table 5 provides a list of the global and local variables used in this model. N represents an integer variable and X is used float variables.

**Table 5. List of variables used in Symphony.NET 4.6**

<b>De finition</b>	<b>Type</b>	<b>Tracked data</b>
GN (0)	Global	Total number of trucks
GN (1)	Global	Total number of haul cycles
LX (0)	Local	The start time of each cycle of trucks (TimeNow)
LN (0)	Local	Number of hauls cycles all trucks
LX (1)	Local	Duration of hauling (TimeNow-LX (0))
LN (1)	Local	Number of haul cycle per truck
LX (2)	Local	Speed of trucks
LX (3)	Local	Fuel consumption of hauling trip
LN (3)	Local	The ID number of each truck
LX (4)	Local	Fuel consumption of return trip
GX (0)	Global	Total fuel consumption in the system
LX (5)	Local	Tire consumption of each truck
LX (6)	Local	Part consumption of each truck
GX (1)	Global	RRMIN of the road
GX (2)	Global	LDRRI of the road
GX (3)	Global	RR of the road at the moment
GX (4)	Global	Total resistance (RR + GR) of the road
GX (5)	Global	RDSMIN of the road
GX (6)	Global	The total load carried by all trucks
GX (7)	Global	RDSMAX of the road
GX (8)	Global	LDRDI of the road
GX (9)	Global	RDS of the road
GN (10)	Global	Total work days
GX (11)	Global	Total tire consumption for the model
GN (12)	Global	Days since the last maintenance
GX (12)	Global	Total part consumption for the model
GX (13)	Global	Total speed for all trucks
GX (14)	Global	Average speed for the model
GX (15)	Global	Maintenance service cost

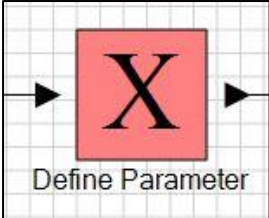
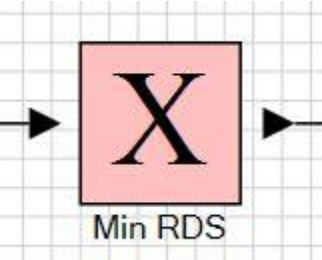
All data can be changed by specific nodes at certain events in this environment. The first step is to define the number of trucks and the interval time for each truck. This step is necessary to calculate vehicle operation consumptions accurately. For example, if the number of trucks was set to 20, it means that the simulation will run the system with 20 operational trucks and will calculate vehicle operation cost for a fleet of 20 trucks (Figure 23). Interval time is also important for the sequencing of trucks to be entered into the system. Table 6 summarizes the nodes used to develop

this stochastic model.

▼ <b>Design</b>	
(Name)	<b>Trucks</b>
Description	
▼ <b>Inputs</b>	
EntitiesPerInterval	<b>1</b>
> First	<b>0</b>
Initialization	(Collection)
> Interval	<b>2</b>
> MatrixSize	<b>0, 0</b>
> Quantity	<b>20</b>
VectorSize	0
▼ <b>Layout</b>	
Color	 <b>192, 192, 0</b>
> Location	<b>-75, 40</b>
> Size	<b>50, 50</b>

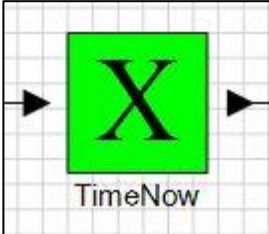
**Figure 23. Determination of trucks number**

**Table 6. Summary of nodes used in the stochastic model**

Node	Node Description and Coding Syntax
	<p>Execute node element provides an opportunity to implement calculation on the variables. Each time an entity (e.g. a truck) passes through this type of node, the system will apply the coded command. For example, if we need a data of a total number of trucks in the model, <math>GN(0) = GN(0) + 1</math> formula enables to count the number of trucks passing this node. Then the LN (3) assigns an ID to each dump truck (e.g. 1, 2, 3... 20).</p> <pre> GN(10) = 1 GN(12) = 1 GN(0) = GN(0)+1 LN(3) = GN(0) Return True End Function End Class </pre>
	<p>The Min RDS node provides some important data to calculate VOC. Before the fleet of trucks starts haulage cycles, road defect score (GX (9)) is equal to RDSMIN (GX (5) ideal condition), and RR (GX (3)) should be equal to RRMIN (GX (1)). Total resistance is defined as a GX (4), and it equals RR plus GR (assumed at 5% in this model).</p> <pre> Public Partial Class Formulas Public Shared Function Formula(ByVal Element GX(1) = 2.71828^(-1.8166+0.0028*40) GX(5) = 31.1919-0.05354*90-0.0152*94 GX(9) = GX(5) GX(3) = GX(1) GX(4) = GX(3) + 0.05 Return True End Function End Class </pre>



**Table 6. continued**

	<p>The simulation model can automatically track the cycle times for each truck using TimeNow node. This Execute type node records the starting time for each truck when they start to move for a haul cycle. Afterwards, when the trucks finish their hauling segment of the cycle (in the node “FCU of Hauling”), the system records ending time. Therefore, the difference between the two elements (TimeNow and LX (0)) gives individual haulage cycle time for each truck. The figure of FCU of Hauling codes shows it as an LX (1), which provides the duration of a hauling trip for each truck. This time is later used for calculation of the vehicle operating consumptions.</p> <pre>LX(0) = TimeNow Return True</pre> <pre>LX(1) = TimeNow-LX(0) LX(3) = (1.02+73*LX(2))*(296*GX(4)+4.5*LX(2))+ SampleUniform(150,163)*LX(2)* (246*GX(4)+0.027*LX(2)^2))*LX(1)*6/10000000 Return True End Function End Class</pre>
---	---

**Table 6. continued**

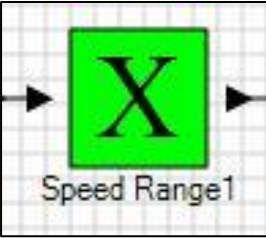
	<p>The Speed Range1 node determines the speed of each truck in the stochastic and dynamic models. Speed is defined as a random variable by Monte Carlo simulation and it is tracked by LX (2). GX (13) represents the total speed for all trucks entire of the model. GX (13) is necessary to calculate the average speed of the model later.</p> <p>Since the speed of the trucks is not a constant value and will follow a probabilistic distribution, a function can be used to determine the speed of each truck from this distribution. For example, the speed of the loaded trucks could vary between 35 km/h – 45 km/h. Thus, the simulation determines the speed of each truck using a random number from this distribution in each run.</p> <pre>LX(2) = SampleUniform(35, 45) GX(13) = GX(13) + LX(2) Return True End Function End Class</pre>
---	--

Table 6. continued

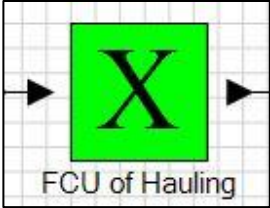
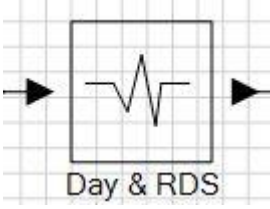
 <p>FCU of Hauling</p>	<p>FCU of Hauling node calculates fuel consumption using equation 3.8.</p> <pre> LX(1) = TimeNow-LX(0) LX(3) = (1.02+73*LX(2)*(296*GX(4)+4.5*LX(2)) + SampleUniform(150,163)*LX(2)* (246*GX(4)+0.027*LX(2)^2))*LX(1)*6/10000000 Return True End Function End Class </pre>
 <p>Day &amp; RDS</p>	<p>We can verify the results to generate some output from our Visual Basic code. For this tutorial, we will use Symphony's trace window for output. The command needed to write to the trace window is called TraceLine. The sample code for TraceLine is shown below:</p> <pre> TraceLine(LN(0)) Return Nothing End Function </pre>

Table 6. continued

In the earthmoving operations, haulage time is an important parameter to establish VOC and maintenance services. During this step, the return time (from unloading to loading site) is calculated using Equation 3.11, and 5 km is the distance of haulage road, and speed is a local attribute (LX (2)) as a random variable (random event). The unit of this equation is an hour, but the simulation model' unit is in minutes. Therefore, it needs to convert the time from hours to minutes, which requires to be multiplied by 60.

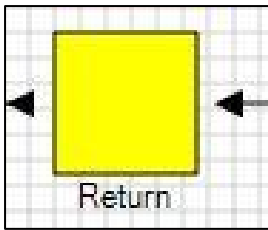
```
Return 5*60/LX(2)
End Function
```

$$x = V * t \quad (3.11)$$

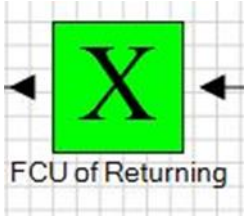
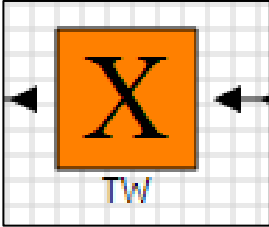
Where, x = road distance (km), V = speed (km/h) and t = time (hour).

While trucks are returning, their weight is lighter. Therefore, LX (2) speed limit should redefine for accurate estimation. While trucks are unloaded, the speed limit will increase. Thus, Speed Range 2 could vary between 40 km/h – 50 km/h for returning a part.

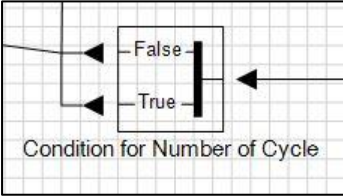
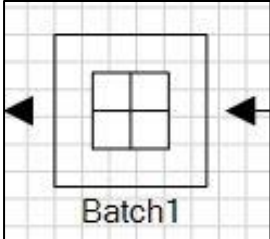
```
LX(0) = TimeNow
LX(2) = SampleUniform(40, 50)
GX(13) = GX(13) + LX(2)
Return True
End Function
```



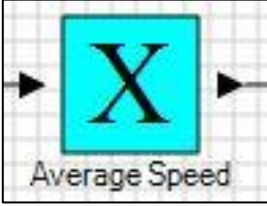
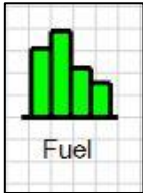
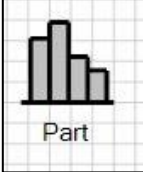
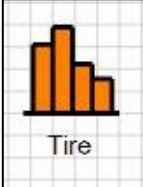
**Table 6. continued**

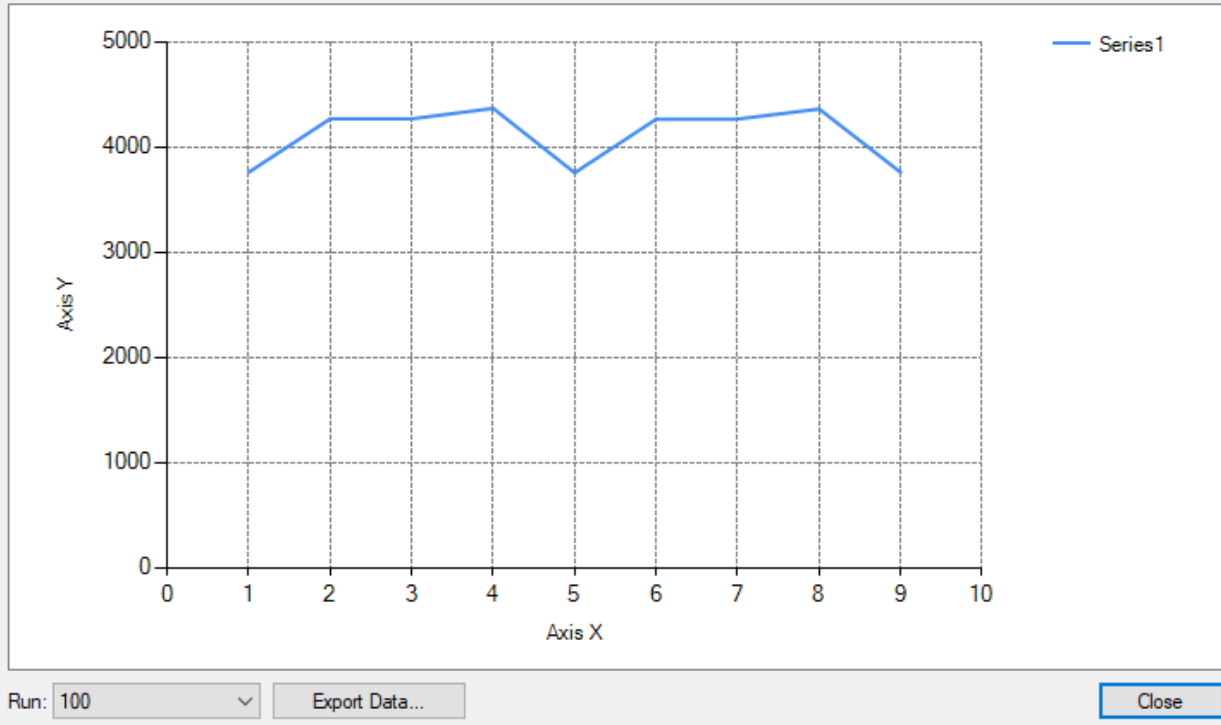
	<p>FCU of Returning similar to the fuel consumption of hauling trips, the FCU of return trips is calculated. However, there is a difference in Equation 3.8 for the return trips, because the L (loaded or not) parameter value is set to 0. The code for calculation of FCU of the return trips is shown below:</p> <pre> LX(1) = TimeNow-LX(0) LX(4) = (1.02+73*LX(2) * (296*GX(4)+4.5*LX(2))) * LX(1) *6/10000000 LN(0) = LN(0) + 1 Return True End Function End Class </pre>
	<p>Tire wear cost coding is illustrated below, and it was calculated for each truck and recorded in the local attribute (LX (5)). Afterwards, we need to calculate tire wear for all the trucks. Therefore GX (11) attribute is included for all trucks active in the model. Caterpillar-type 777 D was used as the sample dump truck in this model. Its standard tire size is 27.00R49 (Caterpillar Performance Handbook, Edition 36), which the unit price of 16,000 CAD (brand new tire). While the simulation calculates GX (11), it requires to multiply tire usage by 16,000 CAD.</p> <pre> LX(5) = (0.098+0.0015*GX(9)+0.002*5)/100 GX(11) = GX(11) + LX(5)*16000 Return True End Function </pre>

**Table 6. continued**

 <p>Condition for Number of Cycle</p>	<p>This node monitors the number of cycles finished by each dump truck. It is a conditional branching node, which examines the number of cycles completed by each truck (LN (20)). The specified condition is 20 cycles per day for each truck; therefore, if a truck completes 20 cycles a day, then it exists the operation loop (using the false branch). Otherwise, the trucks remain operational until they finish their 20 cycles.</p> <pre>if LN(1)&lt;20 then     return true else     return false end if End Function</pre>
 <p>Batch1</p>	<p>Afterwards, the simulation calculates vehicle operating consumptions for the entire fleet using Global variables (G), because G type of variables used to track certain data in the entire model. Batch1 node batches all the dump trucks which completed their cycles in a working day.</p>

**Table 6. continued**

	<p>This node calculates GX (14), which represents the average speed trucks in the entire model. To define the average speed, it requires total speed for all trucks in the global type. GN (1) code represents the total number of haul cycle service, and it is multiplied by two because each cycle has two segments (hauling and returning), and each segment has different speed. The average speed is later used to calculate the increase of RR in that working day (see Equation 3.1 and 3.3).</p> <pre> Public Partial Class Formulas     Public Shared Function Formula (ByVal Element As         GX(14) = GX(13) / (2 * GN(1))         Return True     End Function End Class </pre>
  	<p>VOC (fuel, tire, and parts) results could be documented descriptively and graphically in the Symphony.NET 4.6. A common method is to use chart nodes, which record the values of a certain variable. For example, Figure 24 illustrates the result of fuel consumption per day. In the figure, axis Y shows daily fuel consumption cost (CAD) and axis X shows days. Three chart nodes were used to record fuel, tire, and parts consumption of the fleet.</p>



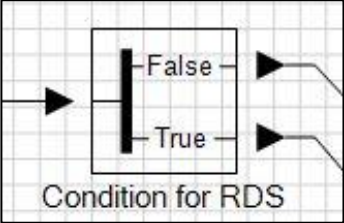
**Figure 24. Chart of Fuel**

**Table 6. continued**

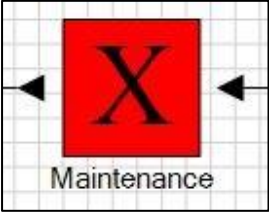
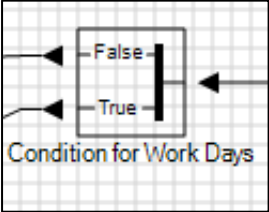
<p>Define Parameters</p>	<p>Define Parameters is an important execute node in which several important parameters are updated. This node calculates new RDS and RR at the end of each working day, based on the speed and load of the trucks.</p>
	<pre> GX (7) = 7.6415+0.4214*(GX (6)/1000)+0.3133*31.1+0.4952*GX (5) GX (8) = 1.768+0.001*GN (12)*(2.69*(GX (6)/1000)-72.75*5-2.59*94- GX (9) = (GX (21)*24.94+GX (22)*32.88+GX (23)*40.82+GX (24)*48.76+0 GX (2) = -6.068-0.00385*GX (9)+0.0061*GX (14) GX (3) = GX (1)+GX (9)*2.71828^(GX (2)) GX (4) = GX (3)+0.05 GN (10) = GN (10)+1 GN (12) = GN (12)+1 GN (1) = 0 GX (13) = 0 Return True </pre>



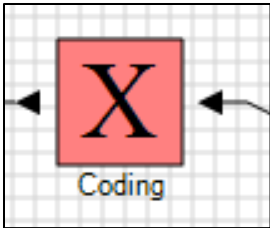
Table 6. continued

 <p>Condition for RDS</p>	<p>Furthermore, the simulation model can monitor road deflection score and apply maintenance at certain levels. Based on the RDSMAX value limit, the system applies maintenance service to decrease roughness score of the deteriorated road. The coding is shown in the below for RDS Condition for the haulage road surface. For example, ConditionalBranch element will route an arriving entity out of one of two branches depending on a specified condition as True or False. If the RDS value of the road is bigger than 66.5 (True), the system will apply maintenance service on the road. If the road RDS values are lower than 66.5 (False), the simulation will continue regular operation in the next working day.</p> <pre>Public Partial Class Formulas     Public Shared Function Formula(ByVal Element As         if GX(9)&gt;66.5 then             return true         else             return false         end if     End Function End Class</pre> <p>The code aims at keeping the haulage roads performance at a predetermined level (prediction model). Based on the RDSMAX, RDS limit condition was defined as a 66.5, but this value could be altered and set at lower values.</p>
--	--

**Table 6. continued**

	<p>The expectation from the Maintenance node is to apply a maintenance service on the roads and decrease the current RDS value to RDSMIN. The objective is to improve the haulage road surface for optimized VOC. Since the RR and RDS are directly related, the RR will be reduced to RRMIN after maintenance. GX (15) is the cost of MMS, and it is explained in detail in section 3.2.1. Maintenance node coding is shown below:</p> <pre> GX (9) = GX (5) GX (3) = GX (1) GX (4) = GX (3)+0.05 GX (15) = 8908 GN (12) = 1 Return True End Function </pre>
	<p>Furthermore, the number of workdays is an important parameter to estimate road deflection and VOC. This ConditionalBranch element can stop the simulation after a certain number of days. For example, the predetermined limit is 20 days in this case; therefore, the simulation will calculate the VOC and road deterioration based on the 20 work days. If the workday condition is less than 20 cycles, the simulation will continue until the 20th day (return true). However, if the workday condition reaches the limit, the simulation will time out and terminate (return false and end function).</p> <pre> Public Partial Class Formulas Public Shared Function Formula()     if GN(10)&lt;20 then         return true     else         return false     end if End Function End Class </pre>

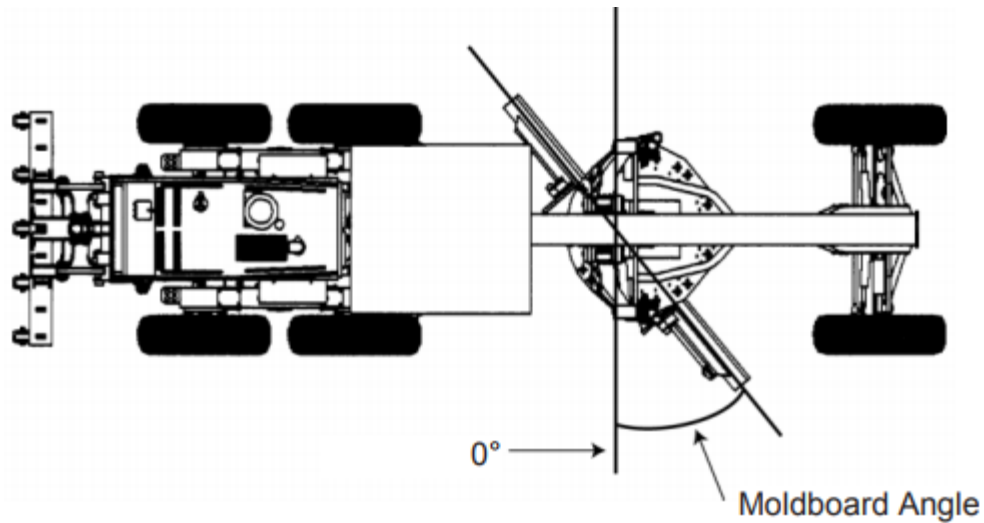
**Table 6. continued**

	<p>Coding node is the last node of the model. After trucks completed a working day, they will start a new day. Thus, before trucks start to a new day, the simulation should reset all the data related to the previous day. The Coding element resets all the related parameters, such as GX (6) (load) and VOC, which includes fuel, tire, and part consumptions values (GX (0), GX (11), and GX (12) respectively). Coding application is shown below.</p> <pre>Public Partial Class Formulas     Public Shared Function Formula(ByVal Element As         GX(6) = 0         LN(1) = 0         GX(0) = 0         GX(11) = 0         GX(12) = 0         Return True     End Function End Class</pre>
---	---

### 3.2.1. Estimation of the Cost of Road Maintenance

Proper road maintenance provides mobility, maneuverability, and good speed for wheel trucks in haulage roads, and loading and dumping areas. For the estimation of the maintenance cost, it is important to obtain local labour, fuel, and equipment cost. Moreover, *MMS* has a big potential to save cost and energy due to the optimum frequency of maintenance service. If *MMS* frequency is at the maximum, *RR* will be at the lowest point, which is the best situation for vehicle operation cost. However, the frequent maintenance cost will increase the overall budget. Also, if the maintenance frequency is minimum, *RR* will be high most of the time, which is an undesired situation. Therefore, it is important to determine an optimal maintenance frequency to optimize the cost in earthmoving operations.

The motor grader is the main type of equipment for maintenance of unpaved roads (Figure 25) and grader time is the critical parameter to estimate maintenance cost. Motor graders are commonly used for bettering drainage, shoulder maintenance, resurfacing, and betterment of the geometric designs, light ripping, and moving and mixing earth material. The haulage road surface materials are usually hard and dry base material on a subgrade. Blading is a motor grader function that improves road surfaces by eliminating rutting and filling the potholes. Grader operation time to maintain a section of a road depends on the number of required graders passes, speed of the grade in each pass and moldboard angle. Enough length becomes shorter as the moldboard angle increases. If haulage roads require heavy blading, it will necessitate increasing moldboard angle.



**Figure 25. Motor Grader moldboard position (Caterpillar Performance Handbook Edition 36)**

Motor grader time can be calculated using Equation (3.12) (Caterpillar Performance Handbook Edition 36). Based on the equation: haulage road length, the speed of the motor grader, efficiency of equipment, and several passes affect the total grader time. Secondly, a water truck is essential for blading a road surface, because it provides better compaction and prevents dusting. Ontario Provincial Standard Specification rates were used for equipment cost rates (Ontario Provincial Standard Specification, April 2018).

$$Time = \frac{P * D}{S * E} \quad (3.12)$$

Where,

*P*: number of the passing of grader,

*D*: distance,

*S*: speed, and

*E*: efficiency.

### 3.3. Markov Chain Stochastic Modelling

Dynamic simulation models aim at modelling parameters that change over time. Road deterioration is an example of a dynamic situation in earthmoving operations because road surface condition will change based on time of operation. The model would likely describe how the roads deteriorate under the heavy trucks' haulage cycles.

The main difference between stochastic and dynamic models is that the dynamic model calculates the road deterioration using Markov Chain principles rather than a mathematical formula. The road deterioration is modelled using a matrix, which is called the Markov transition matrix. It is a square matrix, and each element of this matrix is a non-negative value representing the probability of transitioning from a state to another state (deterioration).

If a state of the system is known, the condition of that state at the time of the process is independent of the state of the system before that time. A Markov transition matrix should satisfy the following two conditions (Hillier, 2000) :

$$0 \leq p_{ij} \leq 1 \quad i, j \in T \quad (3.13)$$

$$\sum p_{ij} = 1 \quad i, j \in T \quad (3.14)$$

Where  $p_{ij}$  is the probability of the transition of the state  $i$  to the state  $j$ , the one-step transition matrix  $P$  is a  $n \times n$  matrix (if the number of the states is  $n$ ) as shown in Equation 3.15. The transition matrix after  $m$  time steps can be calculated using Equation 3.16.

$$P = \begin{bmatrix} p_{11} & p_{12} & p_{13} & \dots & p_{1n} \\ p_{21} & p_{22} & p_{23} & \dots & p_{2n} \\ p_{31} & p_{32} & p_{33} & \dots & p_{3n} \\ \vdots & \vdots & \vdots & \ddots & \vdots \\ p_{n1} & p_{n2} & p_{n3} & \dots & p_{nn} \end{bmatrix} \quad (3.15)$$

$$p_m = p^m \quad (3.16)$$

Also, the summation of transition probabilities from a state  $i$  to all other states must be equal one:

$$\sum p_{ij} = 1 \quad \text{for } 1 \leq i \leq n \quad (3.17)$$

The elements of a transition matrix could be classified into three categories :

- (1) Transient: if the system transits from a state, it will never return to this state again.
- (2) Recurrent: if the system transits from a state, it could return to this state again.
- (3) Absorbing: if the system enters a state, it could never leave this state.

This simulation requires a transition matrix that explains road surface conditions. It was assumed that the RDS of the haulage road could be divided into five states. These five road condition states should be defined in the simulation to track road deterioration parameters. Table 7 summarizes the definition of these states.

**Table 7. List of additional variables used in Symphony.NET 4.6 for the Markov Modelling**

Definition	Type	Tracked data
GX (21)	Global	Excellent road condition
GX (22)	Global	Good road condition
GX (23)	Global	Medium road condition
GX (24)	Global	Poor road condition
GX (25)	Global	Very poor road condition

In practice, the transition matrix should be developed by observation of haulage roads over some time to determine probabilities, which is outside of the scope of this study. The general overview of the simulation model using Markov chain modelling is shown in Figure 26. The model is similar to the stochastic model, except for the Markov transition node functions.

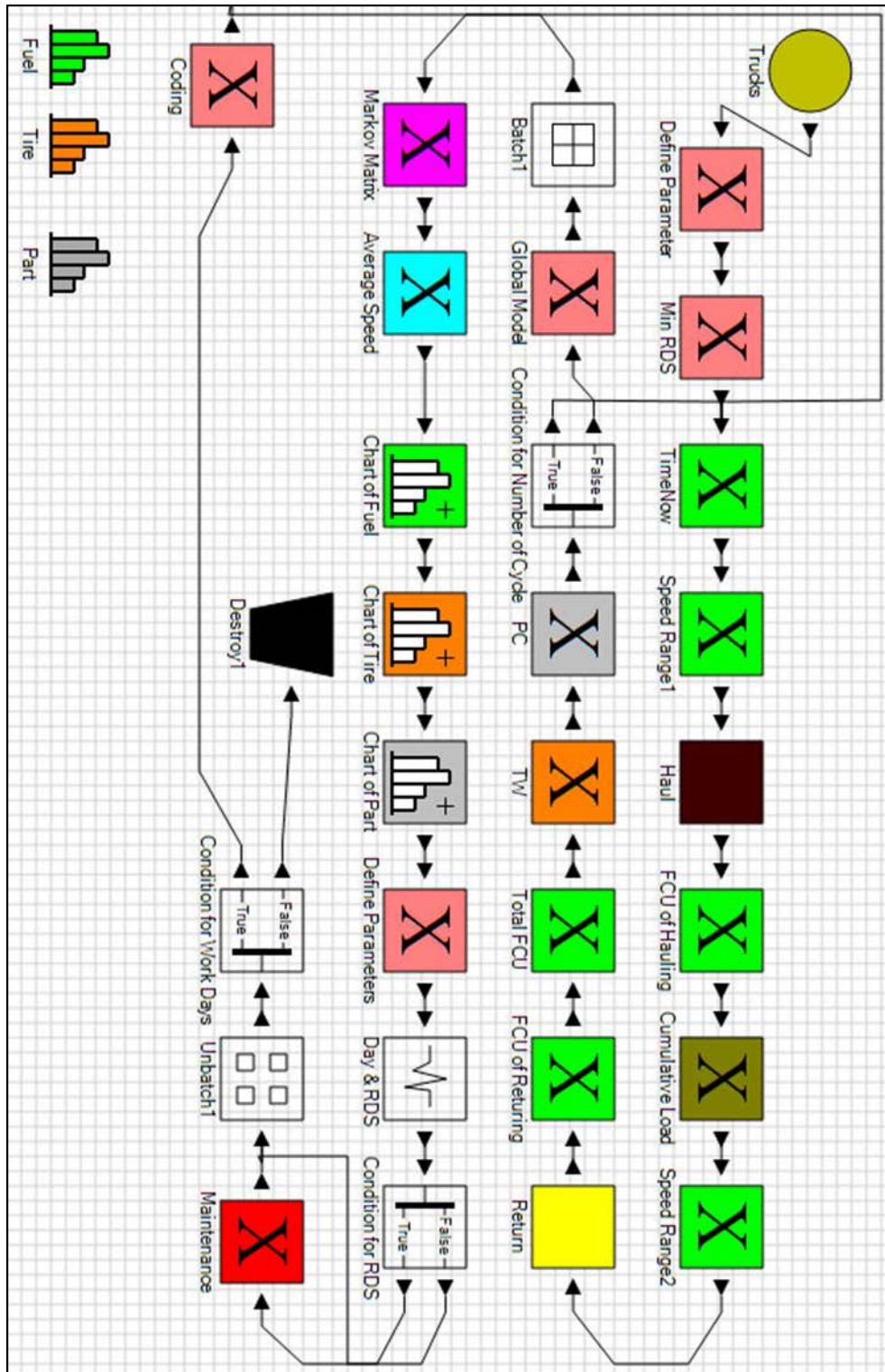
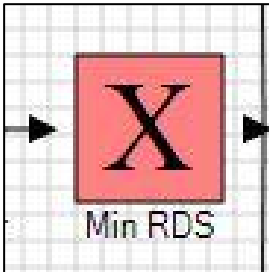


Figure 26. Graphical view of the dynamic model in Symphony.Net 4.6



Dynamic Model and Stochastic model are almost similar to each other, as they use the same equations for VOC. However, a significant difference in the dynamic simulation is modelling of the road deterioration based on the Markov transition matrix, rather than the numerical formula. Table 8 summarizes the nodes in the dynamic model, which are different from the stochastic model.

**Table 8. Summary of the node functions used in the dynamic model**

Node	Node Description and Coding Syntax										
	<p>The coding of the Min RDS node is mostly similar to the stochastic model, except for the road conditions. GX (21) was set to five, which means that the entire haulage road (five kilometres in this example) is in the excellent condition before the trucks start the haulage cycles.</p> <pre data-bbox="521 972 1344 1331"> Public Partial Class Formulas     Public Shared Function Formula(ByVal Element As         GX(1) = 2.71828^(-1.8166+0.0028*40)         GX(5) = 31.1919-0.05354*90-0.0152*94         GX(9) = GX(5)         GX(3) = GX(1)         GX(4) = GX(3) + 0.05         GX(21) = 5         Return True     End Function End Class </pre> <p>Initial matrix is shown below for the Markov Model, and it represents all the road segments are in excellent conditions before trucks start the cycles.</p> <table border="1" data-bbox="516 1524 1154 1604"> <thead> <tr> <th>GX(21)</th> <th>GX(22)</th> <th>GX(23)</th> <th>GX(24)</th> <th>GX(25)</th> </tr> </thead> <tbody> <tr> <td>5</td> <td>0</td> <td>0</td> <td>0</td> <td>0</td> </tr> </tbody> </table>	GX(21)	GX(22)	GX(23)	GX(24)	GX(25)	5	0	0	0	0
GX(21)	GX(22)	GX(23)	GX(24)	GX(25)							
5	0	0	0	0							

**Table 8. continued**

The transition matrix values were assumed in the model. However, in real-world cases, data can be collected from the road surface via crewless aerial vehicles, onboard sensors, visual inspection, or terrestrial laser scanning. Based on the transition matrix values presented below, if there is a road segment in excellent condition, 50% of that will remain in the same state, and the rest will deteriorate to the next state. Therefore, simulation results will change based on the time steps (days) and transition matrix values. Implementation of this transition matrix in the simulation environment is shown below.



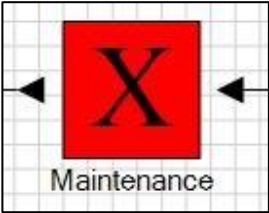
	GX(21)	GX(22)	GX(23)	GX(24)	GX(25)
GX(21)	0.5	0.5	0	0	0
GX(22)	0	0.6	0.4	0	0
GX(23)	0	0	0.5	0.5	0
GX(24)	0	0	0	0.4	0.6
GX(25)	0	0	0	0	1

```

Public Partial Class Formulas
    Public Shared Function Formula(ByVal Element As
        GX(25)=GX(24)*0.6+GX(25)*1
        GX(24)=GX(23)*0.5+GX(24)*0.4
        GX(23)=GX(22)*0.4+GX(23)*0.5
        GX(22)=GX(21)*0.5+GX(22)*0.6
        GX(21)=GX(21)*0.5
        Return True
    End Function
End Class
    
```

RDSMIN and RDSMAX values can be determined according to Equation 3.6 and 3.7. The RDS range estimation can be split into five categories between RDSMIN and RDSMAX values, which represent the five states.

Table 8. continued

	<p>The simulation generates a maintenance service based on the specified condition of RDS. After a maintenance service on the road, the model requires some modifications from the Maintenance node. The implementation of maintenance expectations in the simulation model is shown below. In this case, all the road segments are set to “Excellent” condition after the maintenance service.</p> <pre>GX (9) = GX (5) GX (21) = 5 GX (22) = 0 GX (23) = 0 GX (24) = 0 GX (25) = 0 GX (3) = GX (1) GX (4) = GX (3)+0.05 GX (15) = 8908 GN (12) = 0 Return True End Function</pre>
---	---

The section was shown the methodology for analyzing the relation between VOC and earthmoving operations. During the methodology part, three different numerical models were defined, which are deterministic, stochastic and dynamic models. Three numerical models’ results will be shown in the next chapter.

## Chapter 4: Results

This chapter presents the results of deterministic, stochastic, and dynamic (using Markov chain models) simulations. Based on the results, the relationship between road surface deflection and *VOC* is explained. Some main variable parameters, which affect the *VOC* and maintenance management system (*MMS*), were studied in the simulations. These variables include truck speed, truckload, and soil characteristics. The modelling aims at determining optimum scenarios for earthmoving operations and road surface maintenance activities to minimize the overall operating costs. The results of the Deterministic Modelling are the first to be discussed.

### 4.1. Case Study

In this chapter, a case study was designed to study the proposed modelling approaches. This case represents a routine hauling operation which is carried out on an unpaved haul road with 5 km length (distance from loading to the dump area) and 21.3 m width. This width was calculated according to the following guideline (Tannant and Regensburg 2001):

$$W = (1.5L + 0.5) X \quad (4.1)$$

Where:

W = width of running surface (m)

L = number of lanes (two)

X = vehicle operating width (m) (6.1 m for CAT 777D)

Caterpillar dump truck type 777 D was chosen for the simulation, which has a dual slope body

type, and the gross machine weight (*GMW*) of this dump truck is 163 tones. Also, its payload limit is 90 tones, and its net power and gross power are 699 kW and 746 kW, respectively. Finally, this type of dump truck can reach the top speed (Loaded) of 60.4 km/h. Twenty trucks were considered in the haulage models, and each truck was set to complete 20 haul cycles per day. Thus, a total of 400 haulage cycles occur in a working day. Grade resistance (slope of the road) was assumed at 5% in the haul direction.

## 4.2. Deterministic Model Results

Deterministic modelling includes a set of parameters that remain constant, and the assumption is that they do not change over the modelling timeline (e.g. truck speed is always 40 km/h). It means that there is no randomness or variation in the operations and the *VOC* results. In this setting, truck speed was assumed at 40 km/h. Thus, the duration of a cycle (haul and return) is equal to 0.25 hours. The time for loading and unloading is not considered, as this case study focuses on hauling operations.

The first step is to calculate the *RDS* and *RR* of the road. Equations 3.1 and 3.4 were used for the calculation of road surface deterioration. The assumed parameters used in this model are presented in Table 9.

**Table 9: Summary of assumed parameter values**

<b>V (km/hr)</b>	<b>KT</b>	<b>PI</b>	<b>CBR</b>	<b>GC</b>	<b>SP</b>
40	64	5	94	31.1	90

where,

KT: Average daily tonnage (kt or 1000 tones) (20 trucks x 20 cycles x 160 tones),

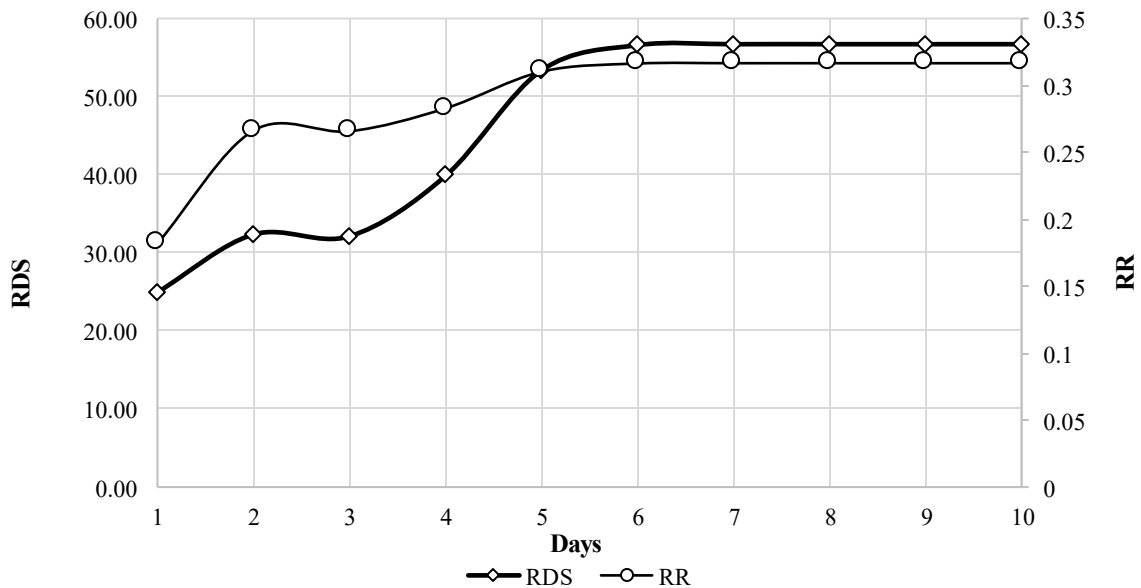
PI: Plasticity Index,

CBR: California Bearing Ratio of wearing course material,

GC: Grading coefficient, and

SP: Shrinkage product.

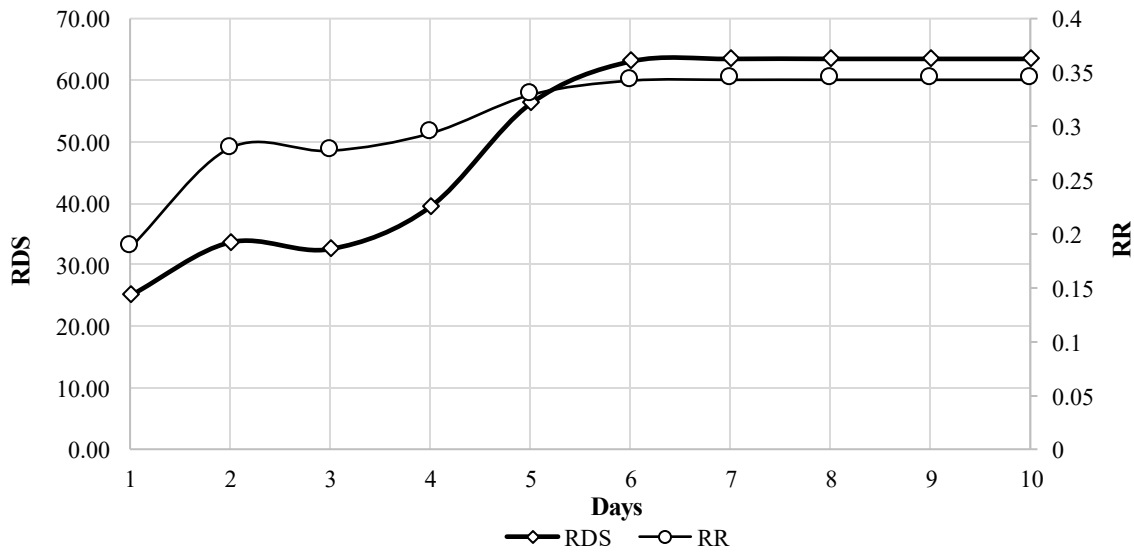
Given these parameters and equations, *RDS* and *RR* values were calculated as the work progresses (with no maintenance) and presented in Table 18 in Appendix and results shown in Figure 27. The results show that as the *RR* increases, *RDS* increases as well. The road surface reaches its worst condition on day sixth and then will remain the same (assuming no maintenance is carried out).



**Figure 27. Deterministic model results for RDS and RR**

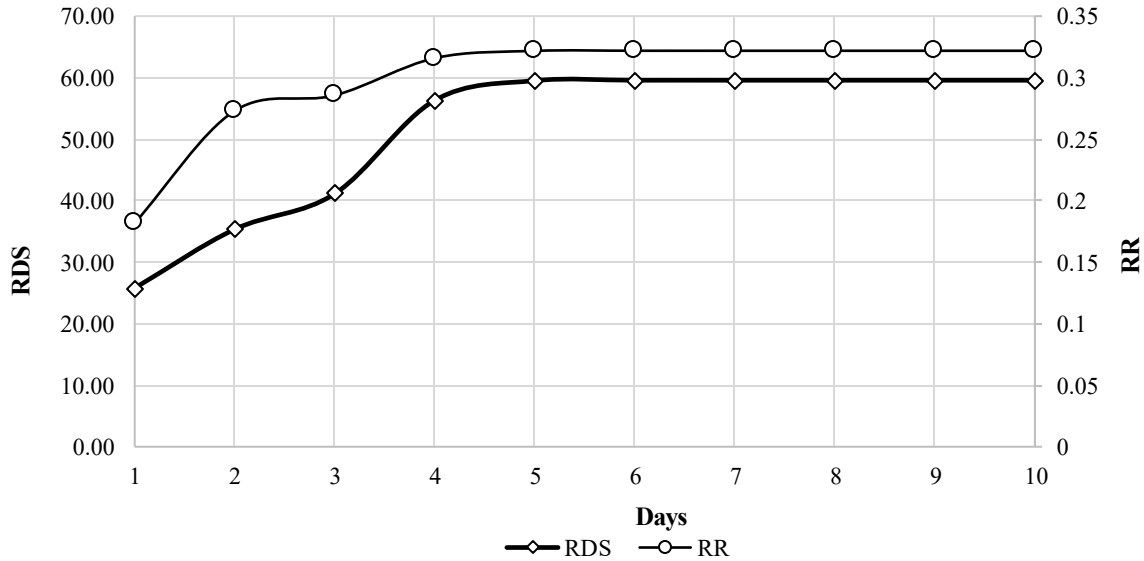
Parameters can be classified into two categories: controllable and uncontrollable parameters. Controllable parameters can be managed in the system to optimize the operation cost, such as

trucks' speed and load, and driver behaviors. Uncontrollable parameters are typically external factors and cannot be controlled, or it is difficult and expensive to control, such as weather, and properties of the wearing course, including  $PI$ ,  $CBR$ ,  $GC$ ,  $SP$ . The truck speed and daily traffic (carried load) were assumed 40 km/hr and 64 kt, respectively. If these parameters are increased by 25%, which means increasing the speed from 40 to 50 km/hr and load from 64 to 80 kt, they will increase  $RR$  by around 8%. Figure 28 shows the increase values of  $RR$  and  $RDS$ , and  $RDSMAX$  increased from 56.70 to 63.45 (around 11%).



**Figure 28. New results for  $RR$  and  $RDS$  based on the increased controllable parameters**

Uncontrollable parameters, namely soil parameters, have a direct effect on  $RDS$  and  $RR$ . However,  $SP$  has an inverse relation with  $RR$  and  $RDS$  values. If the values of parameters with the direct relationship are increased by around 25 % ( $PI$ ,  $CBR$ ,  $GC$ ), and the inverse parameter value is decreased by 25 % ( $SP$ ), they will increase the  $RDSMAX$  from 56.70 to 59.57 (about 5%). Figure 29 illustrates the new values of  $RR$  and  $RDS$ .



**Figure 29. New results for RR and RDS based on increased uncontrollable parameters**

Changing the parameters' value shows that the alteration of the main controllable parameter's values, including truck speed and load, have a larger impact on the road surface condition than the soil characteristics. These trends are useful to determine optimum values of *RR* and *RDS* for *VOC*. The next step is to estimate the *VOC* (in Canadian dollars) with the mentioned assumptions.

This section shows the calculation of total cost for *VOC*, which includes fuel, tire, and parts consumptions. Also, it explains how the parameters affect the consumptions. Therefore, the findings have the potential to show an approach to optimize *MMS* and *VOC*. The fuel consumption is the first *VOC* item to be discussed.

#### 4.2.1. Fuel Consumption Estimation

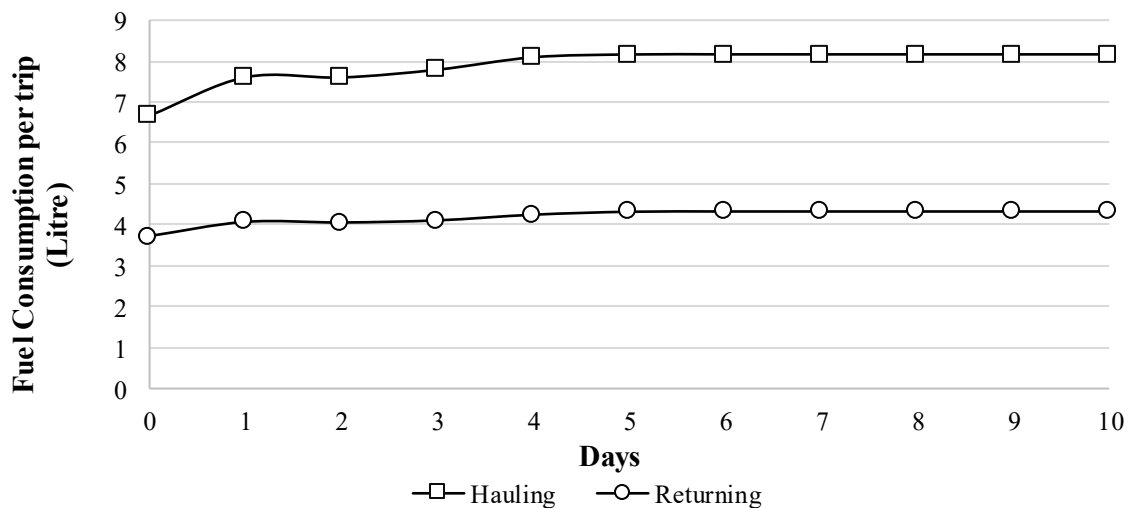
Equation 3.8 was used for the fuel consumption calculation. Based on the equation, fuel consumption varies with rolling resistance. This equation requires some parameters, and Table 10 provides the parameter values which were determined based on the defined case.



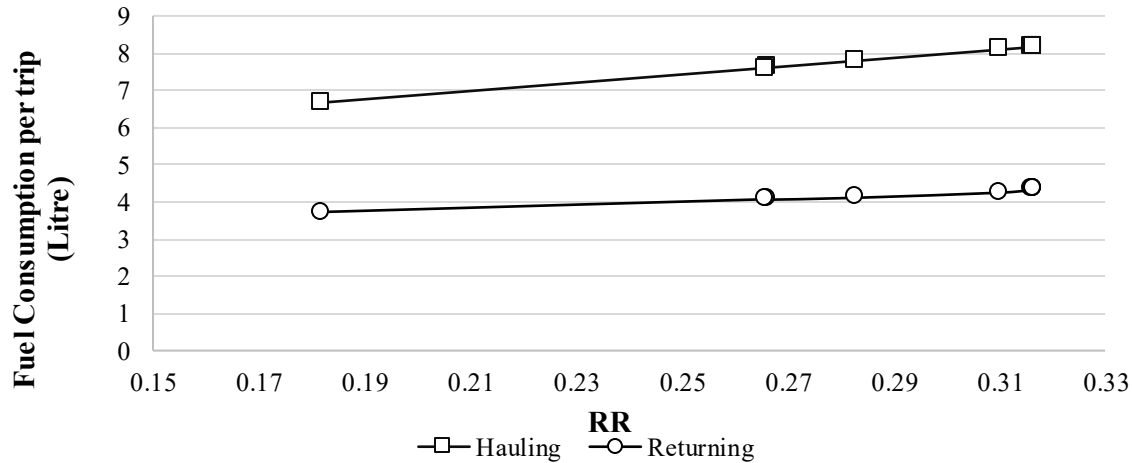
**Table 10. Parameters' values used to estimate fuel consumption**

UVM (unloaded truck)	V (speed)	TRU (GR+RR)	L	GVM (loaded truck)
73 tons	40 km/h	0.05 + RR	0 for empty 1 for loaded	163 tons

The proposed model for fuel consumption includes unfavorable fuel consumption ( $TR \geq 0\%$ ).  $TR$  is equal to  $RR$  plus grade resistance ( $GR$ ). Unloaded vehicle mass ( $UVM$ ), which means the empty weight of the truck, was assumed 73 tons (Caterpillar Performance Handbook Edition 36). Total resistance ( $TRU$ ) is equal to grade resistance ( $GR$ ) plus rolling resistance ( $RR$ ). Figure 30 and Figure 31 illustrate the results for fuel consumption using the deterministic model. The effect of truckloads can be seen in Figure 30, where the trucks consume considerably more fuel in the hauling trips than the returning trips. Figure 30 also shows the results, where the fuel consumption increases until day sixth, and then it remains constant because the  $RR$  reaches the maximum value at day six and then remains constant.



**Figure 30. Fuel consumption on each hauling and returning trip**

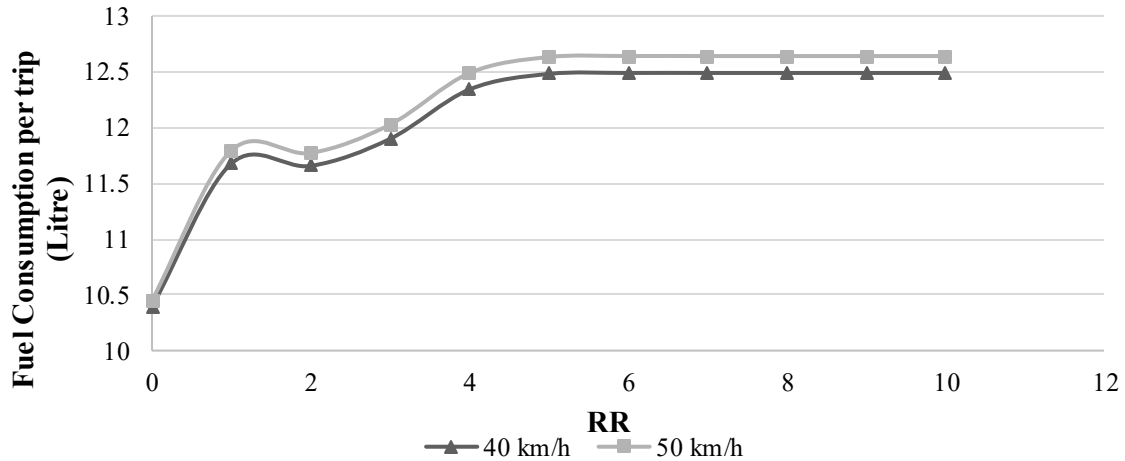


**Figure 31. Fuel consumption per trip based on rolling resistance**

While using Equation 3.8, fuel consumption unit is ml/s; however, it can be converted to L/hr. The equation estimates fuel consumption for each cycle. If the daily fuel consumption estimation is multiplied by the total number of haul cycles and the cost of fuel (is assumed 1.2 CAD per Liter), it gives the fuel consumption result as a cost item per working day. Thus, fuel consumption was estimated at 117,734.707 CAD for 20 working days using the deterministic modelling approach.

If the daily carried tonnage is increased by around 10%, from 64kt to 70.4kt, fuel consumption will increase from 117,734.707 CAD to 118,157.140 CAD. In another scenario, if the speed is increased by 10% (from 40 km/hr to 44 km/h), the fuel consumption will increase from 117,734.707 CAD to 118,271.590 CAD.

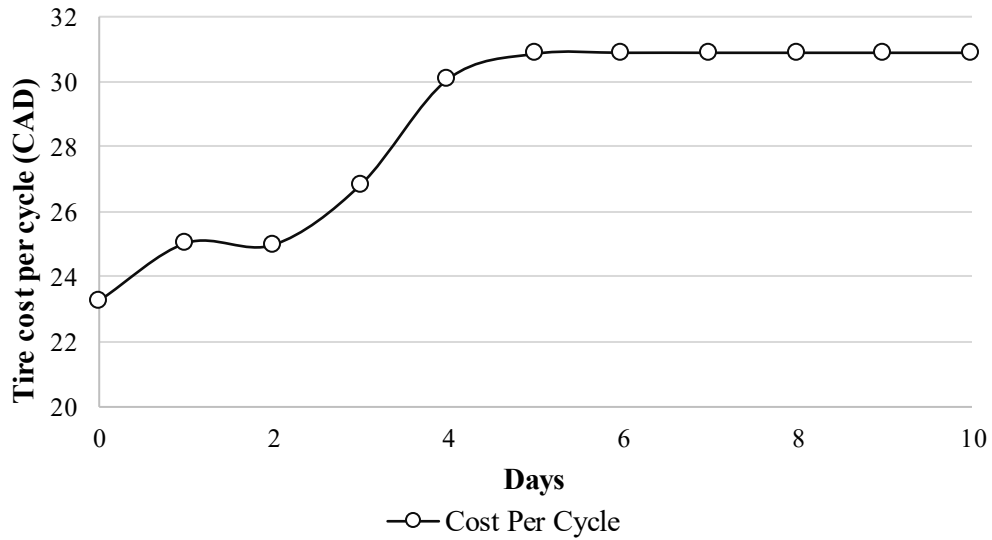
Figure 32 shows the fuel consumptions of trucks at different operating speeds, including 40 km/h and 50 km/h. The energy consumption of trucks 40 km/h is much less than higher speeds, such as 50 km/h.



**Figure 32. Fuel consumptions at different speed limits**

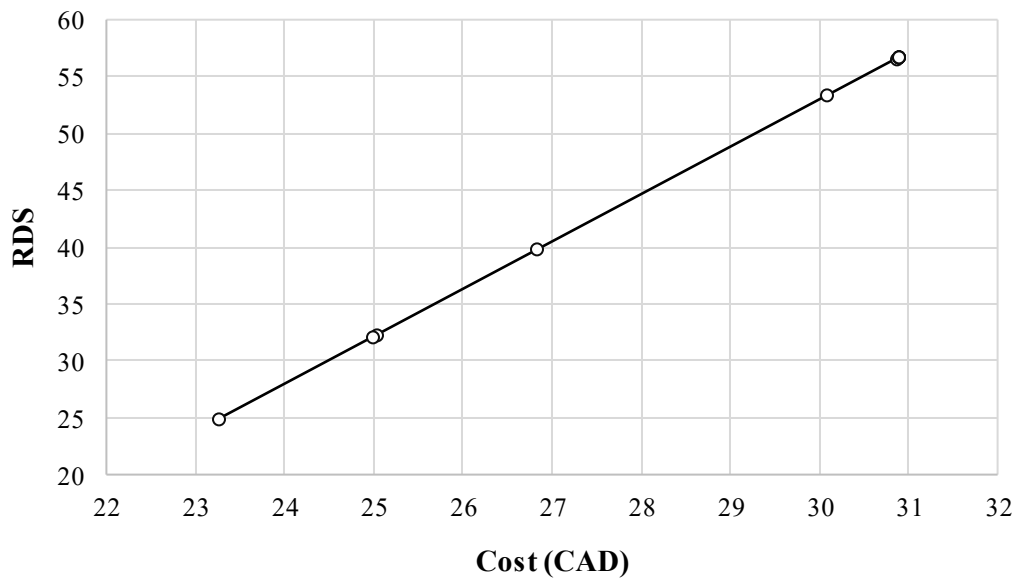
#### 4.2.2. Tire Wear Estimation

Tires are significant cost items in the operations because they are the only parts of a truck which are in contact with the haulage road surface and suffer from accelerated wearing. Also, it is expensive to purchase and to retread tires. The Caterpillar 777 D tire size is 27.00R49 (Caterpillar Performance Handbook Edition 36), and the estimated cost of a tire is around 16,000 CAD. Equation 3.9 was used for the tire wear calculation. The most critical parameters are *RDS* and *GR* for tire wear estimation. Based on Equation 3.9, Figure 33 shows the cost of tire wear.



**Figure 33. Tire wear cost per truck in each cycle**

The road surface deteriorates as the working days progress; therefore, tire wear cost increases as well. Figure 34 shows the relation between *RDS* and *VOC*.



**Figure 34. Tire wear cost based on RDS per trip**

If the tire wear consumption results are multiplied by 400 (20 truck working 20 cycles), it will give the total cost of tire wear for the entire of the model, which will be 237,418.700 CAD for 20

work days. If *RDS* increases around 10% that, from 24.948 to 27.442, the tire cost will increase by around 2.6%.

### 4.2.3. Part Consumption Estimation

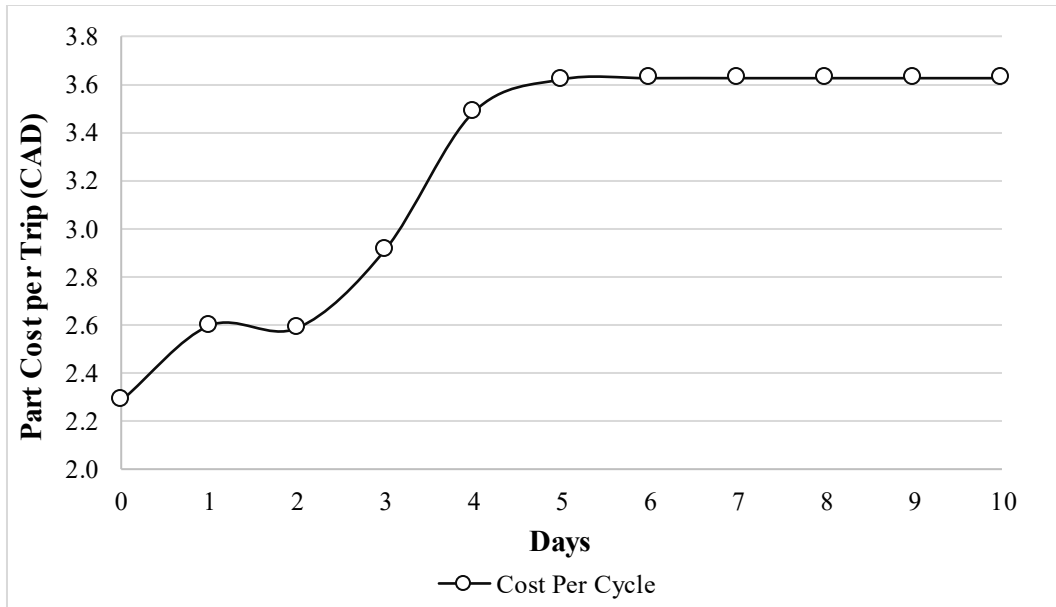
Mining and heavy engineering industries use large dump trucks. The parts of these trucks are expensive and time-consuming to repair or replace. Fixing and replacement of the truck part are time-consuming, which inactivate that truck and reduces the productivity of earthmoving operations. In part consumption, the most critical parameter is *RDS*. If *RDS* values increase, parts cost will rise too. There is a relationship between *RDS* and part consumption. Equation 3.10 was used for the part consumption calculation.

Furthermore, part consumption is related to a few parameters, such as replacement cost of equipment, *RDS* and age of the vehicle (operating hours). Adopted data provides the replacement cost and the age of vehicle parameter values. Table 11 provides the value of these parameters, which were used in the calculation of the part cost.

**Table 11. Summary of parameter values for part consumption analysis**

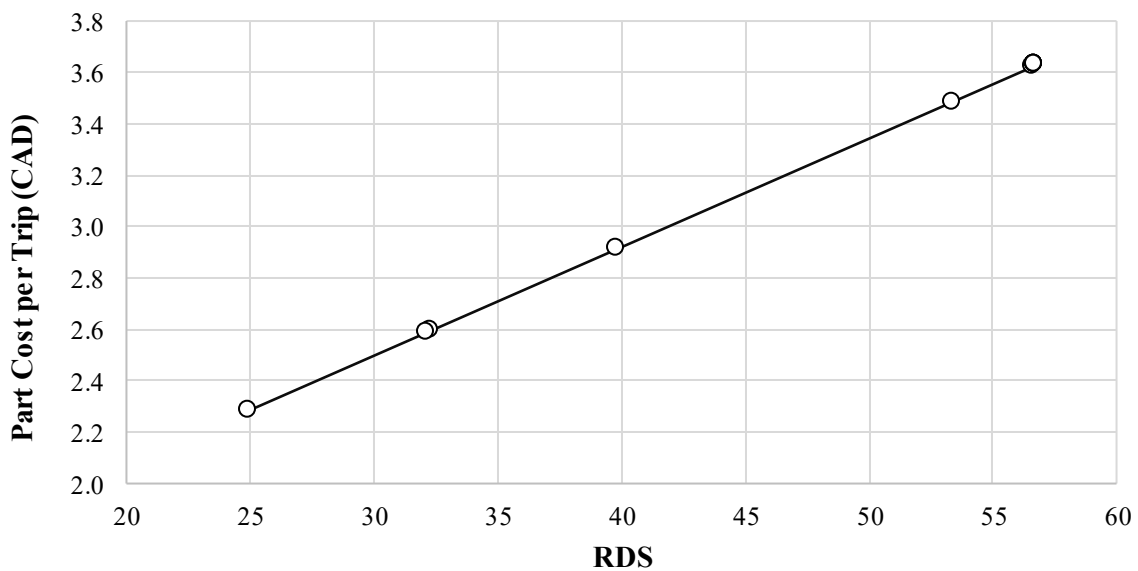
Vehicle Age (H) (Total operating hours)	Replacement Cost of Truck (VP)
5000	150,000 CAD

Figure 35 illustrates the cost of the parts per trip at different working days. If the cost of the parts per trip is multiplied by 400, it will provide parts cost values for all trucks. Based on the result, the total part cost is 40,946.494 CAD for 20 work days. An important relationship is between the age of vehicle and parts cost, where the older trucks require more expenditure on the parts. For example, if the working hours of trucks are reduced by 10%, the cost of the parts would decrease by around 4%.



**Figure 35. Part consumption based on the working day**

Figure 35 illustrates parts consumption cost per trip and Figure 36 shows the relationship between *RDS* and parts cost per trip.



**Figure 36. Part consumptions for each truck and per trip**

Based on the results of deterministic modelling, total *VOC* is 396,099.564 CAD for 20 days (Figure 37 and presented in Table 19 in Appendix), and *RDS* is a significant factor in the vehicle

operating cost, which could be controlled by an optimal maintenance plan. An effective maintenance service can reduce the roughness score to  $RDSMIN$ , which can minimize the  $VOC$ . However, the cost of maintenance is an essential parameter to optimize maintenance frequency and  $VOC$ . The next section discusses the maintenance cost estimation.

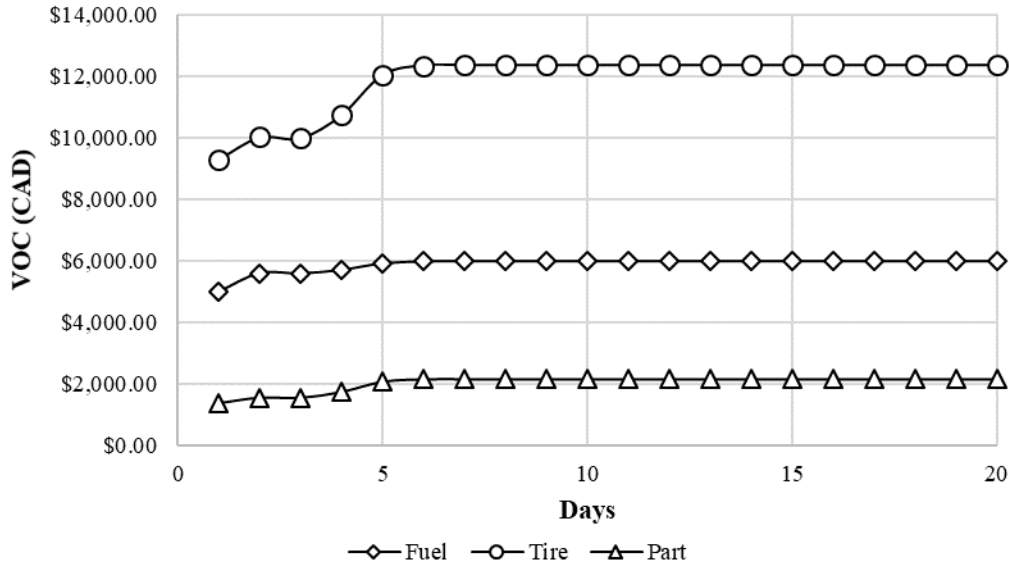


Figure 37. VOC estimation using deterministic modelling

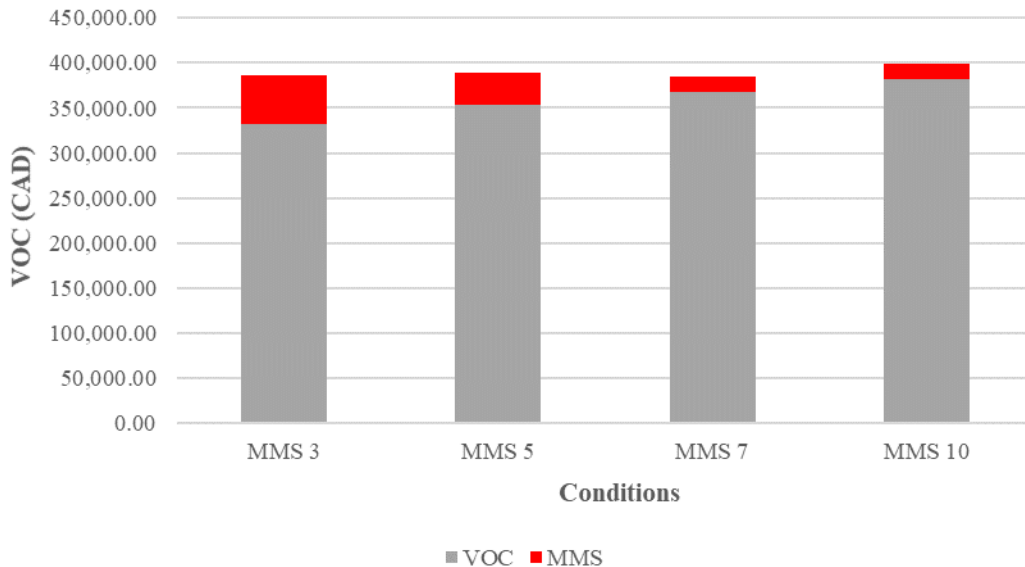
#### 4.2.4. Maintenance Cost Estimation

A motor grader is the most important equipment to level deteriorated unpaved road surfaces (Figure 3.4). The time of motor grader operation is the most important parameter to estimate maintenance cost, which was calculated using Equation 3.11. As a result, the maintenance service of the case road will cost 8,908 CAD. Table 12 presents all the used values to calculate the maintenance cost.

**Table 12. Maintenance parameters used to calculate maintenance cost**

	Number of Passes	Total Operation Hours	Total Operation Cost CAD	Moldboard Angle
Maintenance Service	2	15.555 (16)	8,908.60	45 (2.6 m)

Passing the time of grader is critical in maintenance cost, and it depends on the grader blade width (Regular blade width is 3.66 m) and road surface conditions. Increasing the moldboard angle will reduce its effective width, but it will increase the efficiency of the grader (it needs fewer passes). For example, if the moldboard angle is 30 degrees, the effective width of the blade becomes 3.2 meters, but if the angle is set to 45degree, effective blade width will become 2.6 meters. The final step is to estimate an optimal frequency for the maintenance service. Based on the deterministic model, the best optimal frequency was found to be a service every seven days, which gives a minimum cost with 385,077.29 CAD for the total of *VOC* (Figure 38 and numbers are presented in Table 20 in Appendix).

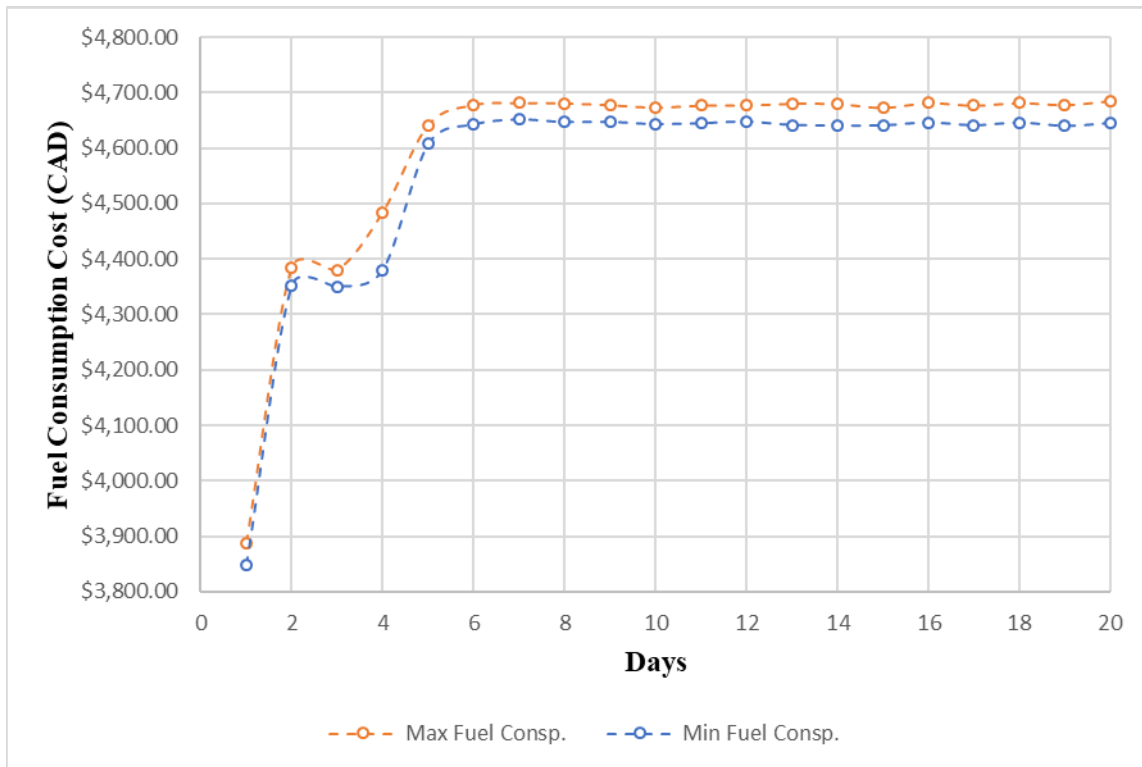


**Figure 38. The optimal frequency of maintenance service in the deterministic model**



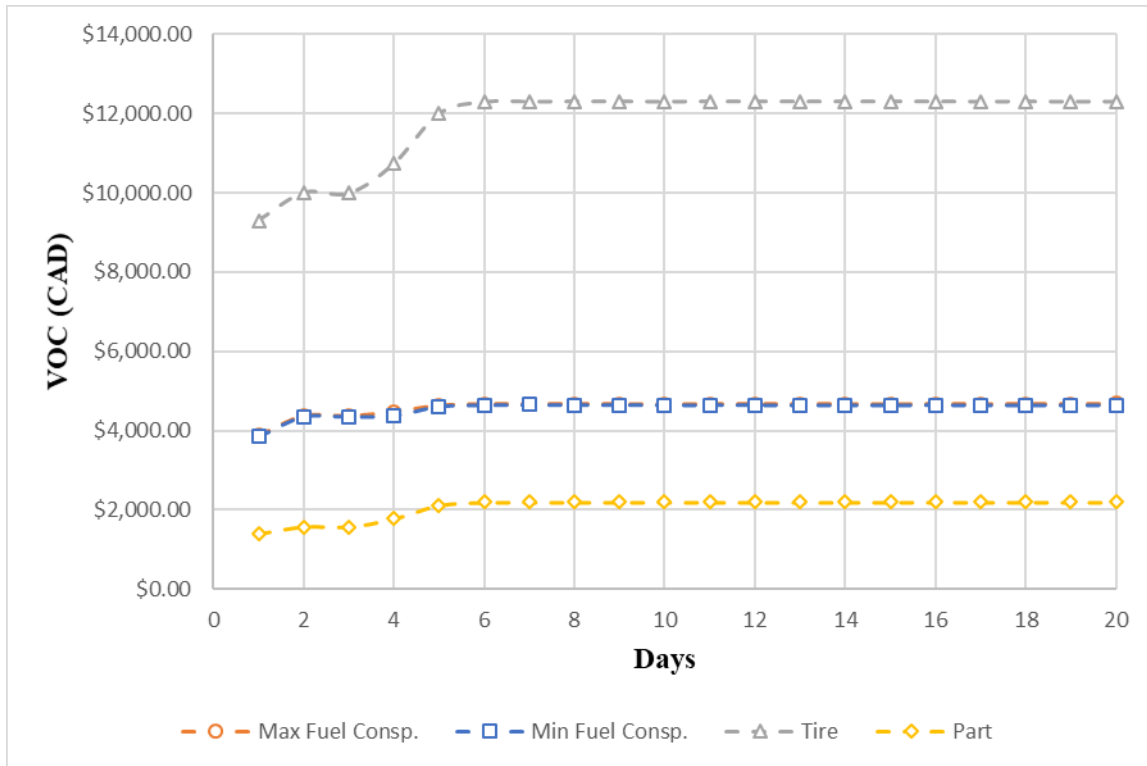
### 4.3. Stochastic Modelling Results

In the stochastic modelling, the speed and load of trucks were randomly selected from probabilistic distributions, which were 150 to 163 tones for load, 35 to 45 km/h for haul speed, and 40 to 50 km/h for the return speed. Figure 39 shows the limit between the maximum and minimum fuel consumptions observed in the simulation runs (100 runs) in the stochastic model.



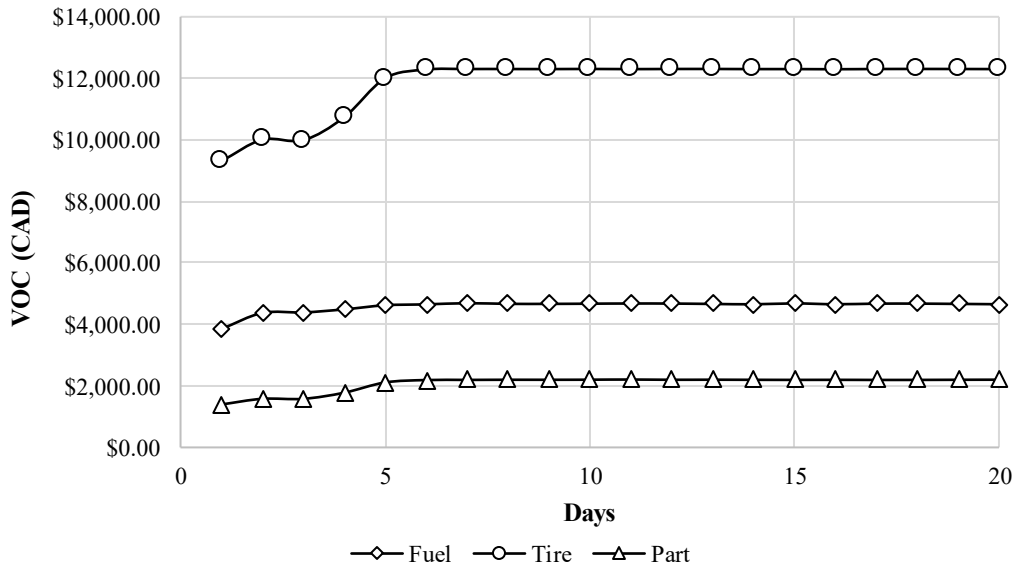
**Figure 39. Stochastic model vehicle fuel cost results**

Figure 40 illustrates the fuel, tire, and part consumptions estimated using the stochastic model for 20 days. Numerical data are also reprinted in Table 21 in the Appendix.



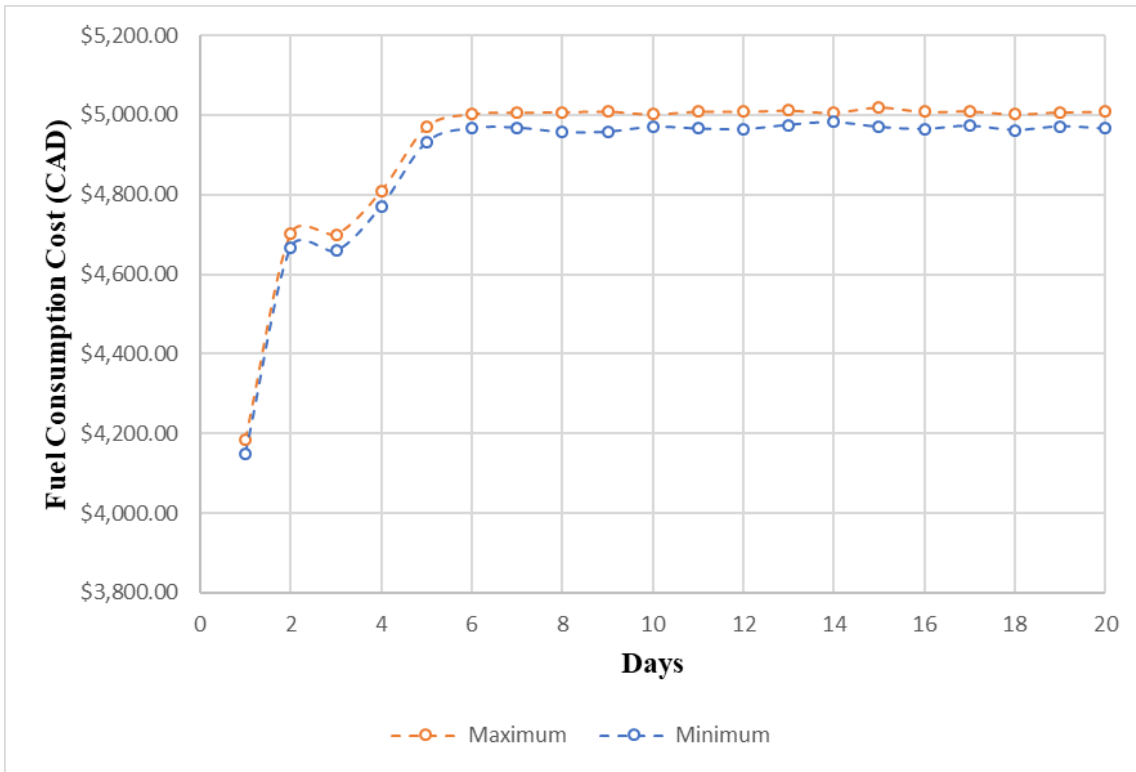
**Figure 40. Stochastic model vehicle operating cost (VOC)**

Based on the results, minimum total fuel, tire and parts consumptions cost was 369,110.82 CAD (maximum 369,869.13 based on the different simulation runs), which is less than the deterministic model consumptions. If we change the distribution type from uniform to the normal distribution ( $\mu, \sigma$ ), vehicle operating cost is 369,678.00 CAD for 20 work days (Hauling speed value is (40,5), Returning speed value is (45,5) and for load (157,6)) (Figure 41).

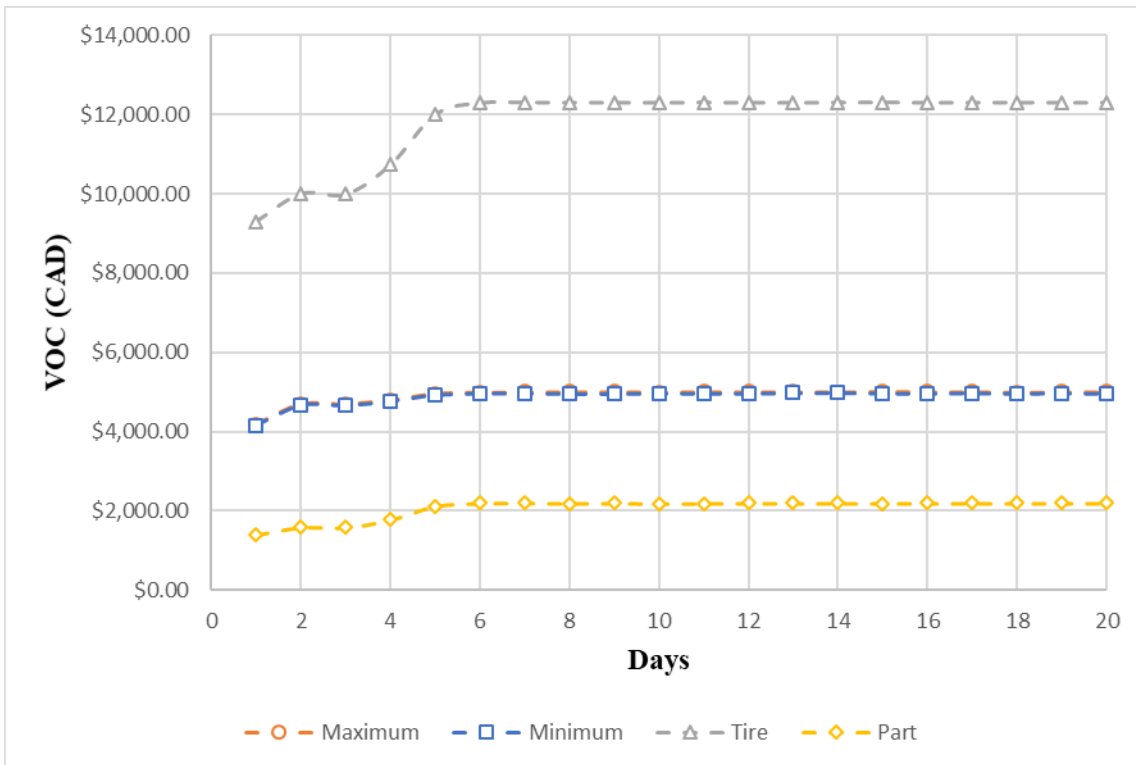


**Figure 41. Stochastic Model VOC for Normal Distribution Type**

Moreover, if the speed of truck increases by around 10 % (38.5 to 49.5 km/h for haul speed and 44 to 55 km/h for the return speed), fuel consumption will increase by around 7.10 % in the stochastic model. Seven percentage is a big difference for heavy engineering and mine industries, considering that the Caterpillar 777D truck has a large fuel consumption rate, which could be 53 to 74 liters per hour in medium operating conditions (Caterpillar Performance Handbook Edition 36). Based on the 10 % increased speed, minimum total vehicle operating cost rises to 376,380.14 CAD. Figure 42 illustrates the range of maximum and minimum fuel consumption (based on 100 simulation runs) and Figure 43 shows all VOC costs.

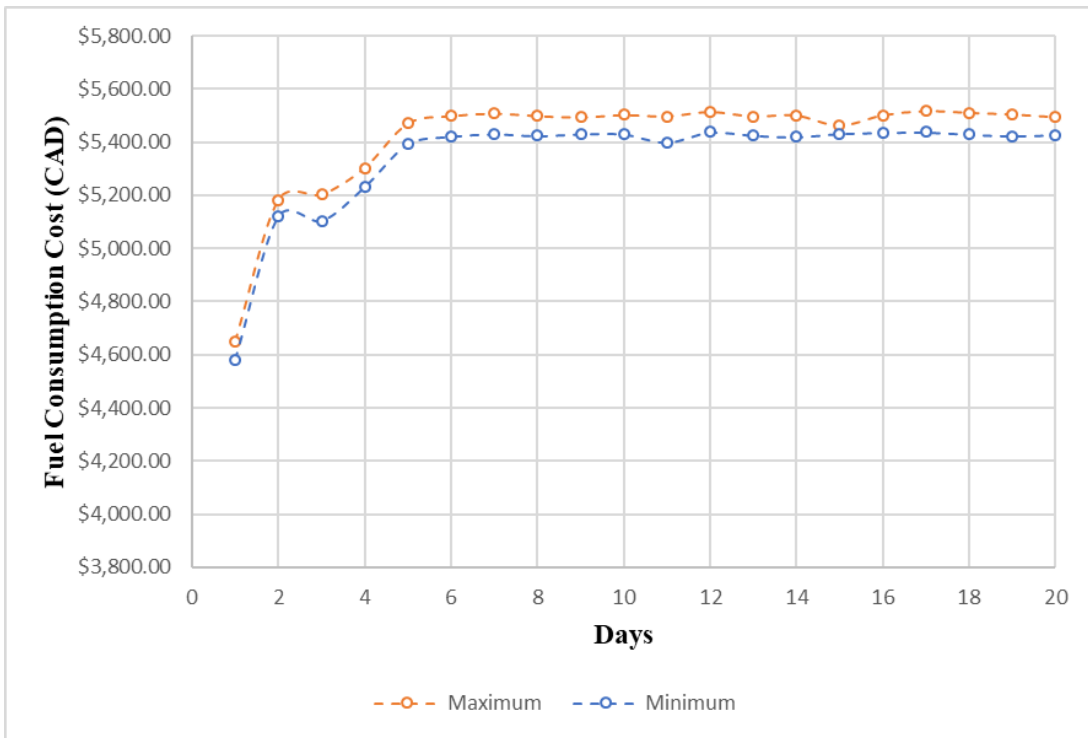


**Figure 42. Fuel consumption range after increasing speed**

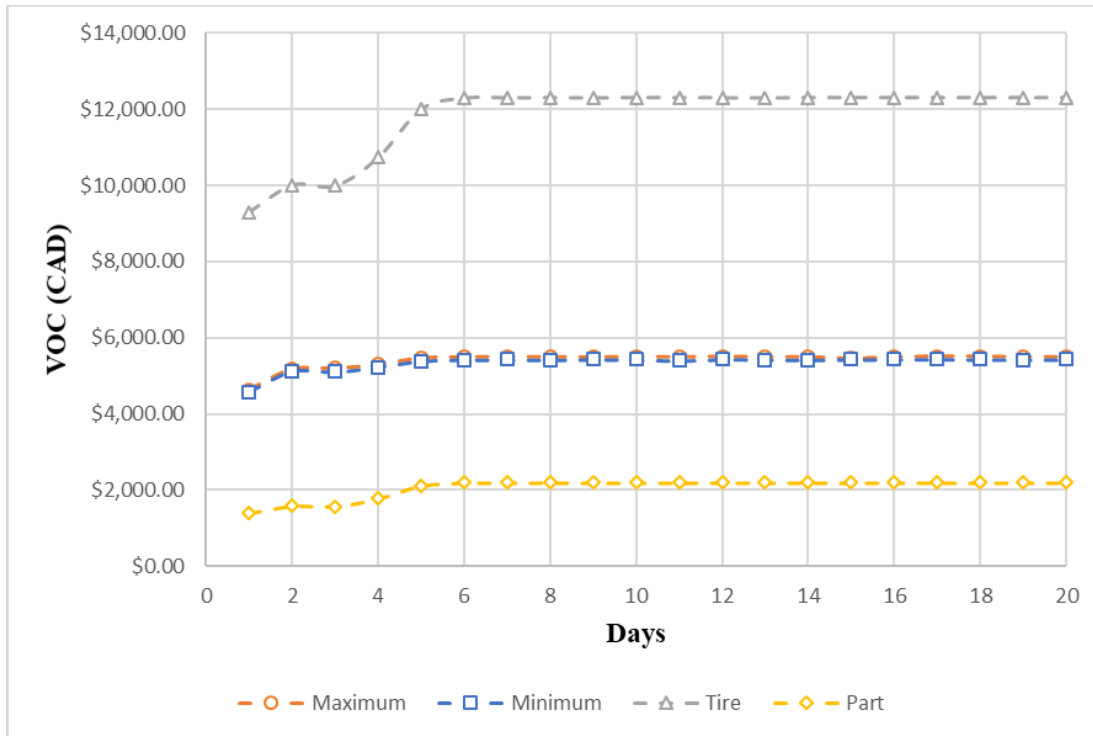


**Figure 43. VOC results after increasing speed limits**

Another scenario was to change the speed range (initial ranges were 35-45, 40-50 km/h). The speed range was changed to 40 to 60 km/h for hauling and 45-65 km/h for the returning trips, which is possible with 777D Caterpillar trucks. The maximum VOC observed in the simulation runs was 386,232 CAD, and the minimum total vehicle operation cost was 384,760 CAD. The results of the fuel consumption range are shown in Figure 44, and Figure 45 provides the VOC results.

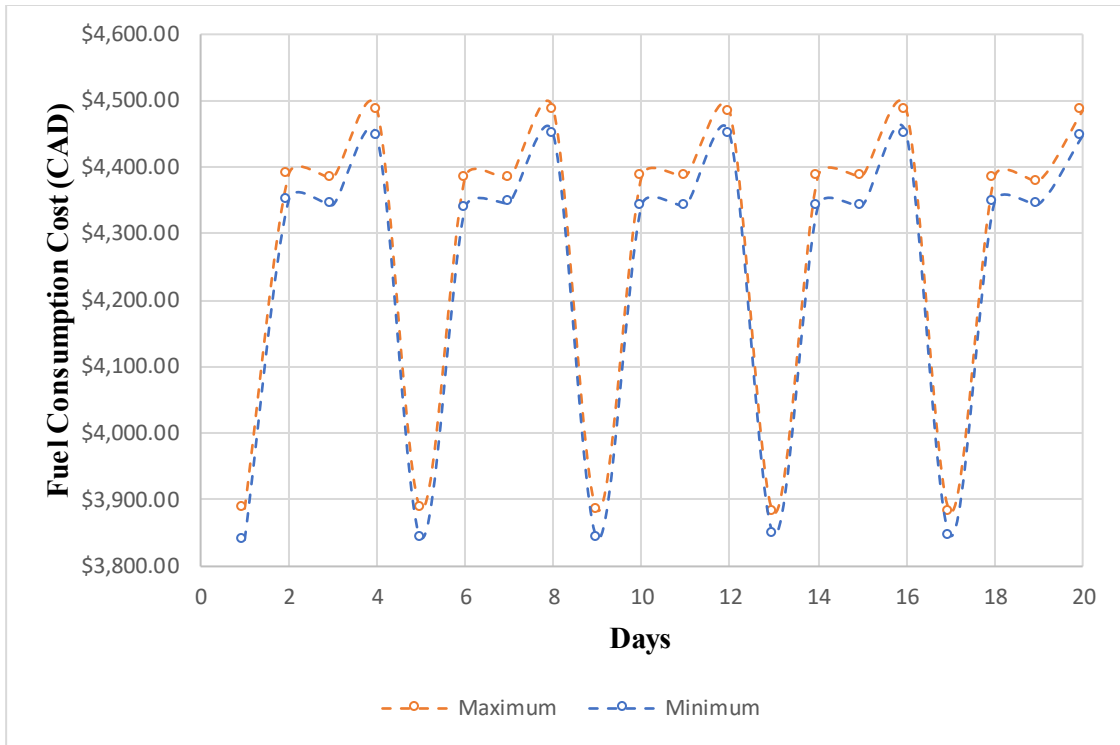


**Figure 44. Fuel consumptions after increasing speed ranges**

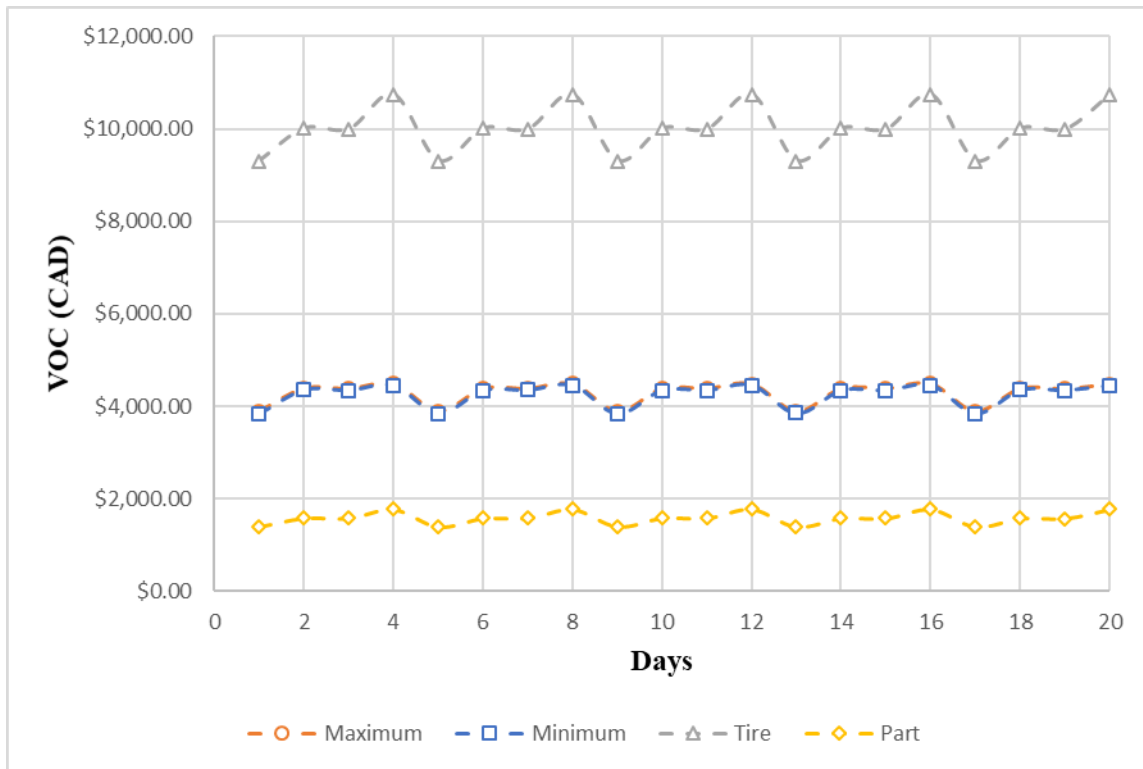


**Figure 45. VOC after increasing the speed ranges**

All the previous simulations were carried out without considering a maintenance service. Then the system was set to carry out a maintenance service if RDS reaches 50. Figure 46 shows the fuel consumptions range and Figure 47 illustrates total VOC in this setting. As it is apparent in the figures, the system needs four times maintenance services in 20 workdays (one maintenance service every five working days), and the minimum total vehicle is operating cost was 316,711 CAD. These VOC results are significantly lower than the VOC results without maintenance.

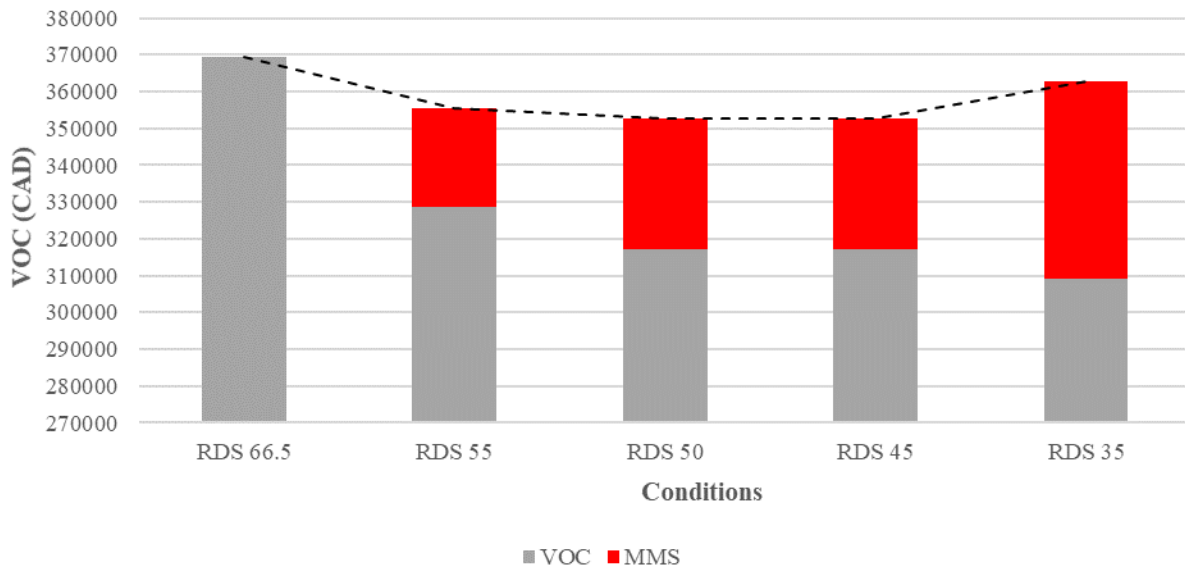


**Figure 46. Fuel consumptions with maintenance at RDS 50**



**Figure 47. VOC results with maintenance at RDS 50**

Although maintenance services reduce the VOC, each maintenance service is costly and should be considered in the total operating costs. Using different maintenance scenarios, users can choose an optimal frequency. Figure 48 shows the total operating cost based on different RDS thresholds to carry out a maintenance service and is the numerical data are presented in Table 22 in Appendix.



**Figure 48. Comparison of the total cost in different maintenance scenarios**

Based on these outcomes, maintaining the road at RDS 50 (every five days) results in the lowest total VOC and shorter intervals does not provide a better total operating cost.

#### 4.4. Markov Modelling Results

In dynamic modelling, the road deterioration rate changes based on time. This model represents the way that the road deteriorates under operation. The Dynamic model was developed using the Markov chain transition, in which the roughness defects score of the segments of haulage road changes probabilistically over time. The sample transition matrix used in this case study is

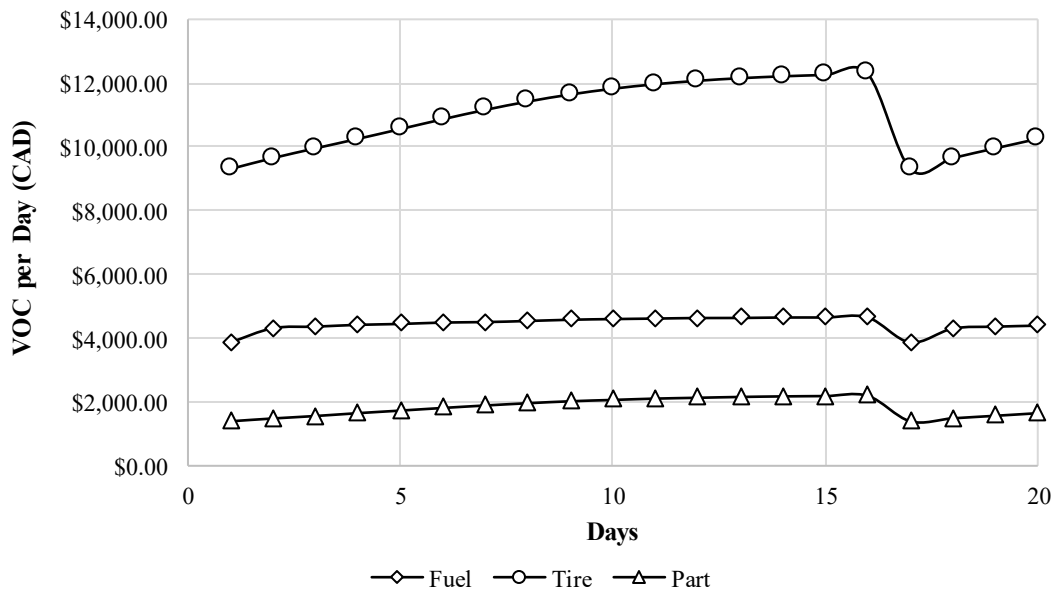


presented in Table 13.

**Table 13: A sample transition matrix values**

Surface condition	Excellent	Good	Medium	Poor	Very poor
Excellent	0.5	0.5	0	0	0
Good	0	0.6	0.4	0	0
Medium	0	0	0.5	0.5	0
Poor	0	0	0	0.4	0.6
Very poor	0	0	0	0	1

Vehicle operating costs were calculated based on this initial transition matrix, and the results are shown in Figure 49. The model was also set to carry out a maintenance service when it reaches maximum RDS, which was determined at every 16 days. Based on the transition matrix, VOC is 344,271.45 CAD, which is less than VOC of the stochastic model, and it is provided in Table 23 in Appendix.



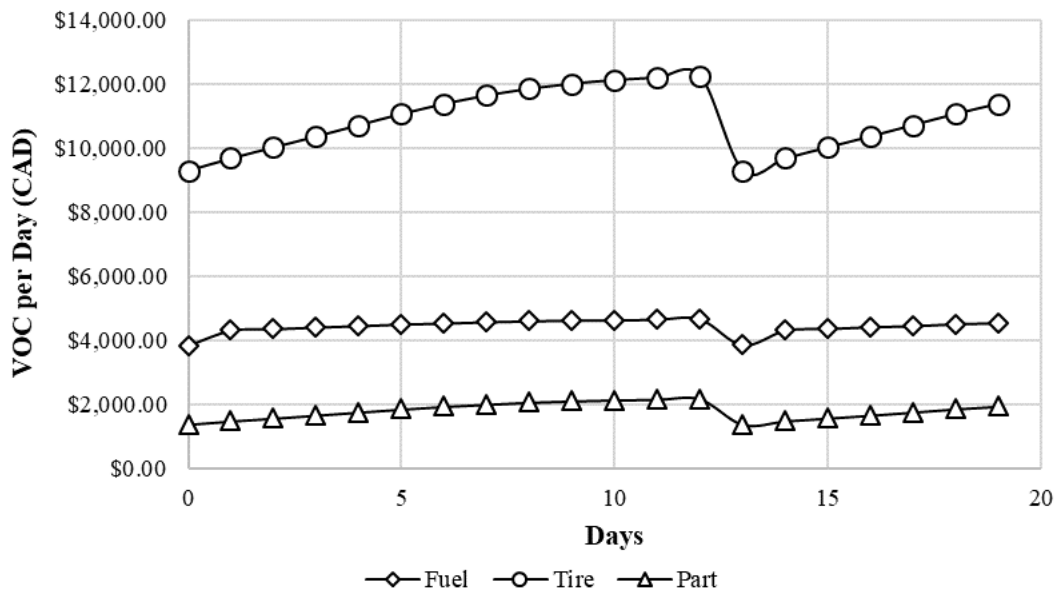
**Figure 49. VOC results based on the transition matrix**

The values of the transition matrix were assumed in this study. However, real values can be collected using existing sensing technologies, such as image processing and terrestrial laser

scanning. The structural and functional design parameters, the operational condition of the haulage road affects the transition matrix. Improving the design of the haulage road will reduce the adverse (negative) effects. Table 14 provide values for the transition matrix, which increased by 10 % (getting better condition), which causes a change in the *VOC* results that are illustrated in Figure 50. Based on the results, *VOC* decreases from 344,271 CAD to 342,294 CAD.

**Table 14: Transition matrix values after improvement**

Surface condition	Excellent	Good	Medium	Poor	Very poor
Excellent	0.55	0.45	0	0	0
Good	0	0.66	0.34	0	0
Medium	0	0	0.55	0.45	0
Poor	0	0	0	0.44	0.56
Very poor	0	0	0	0	1



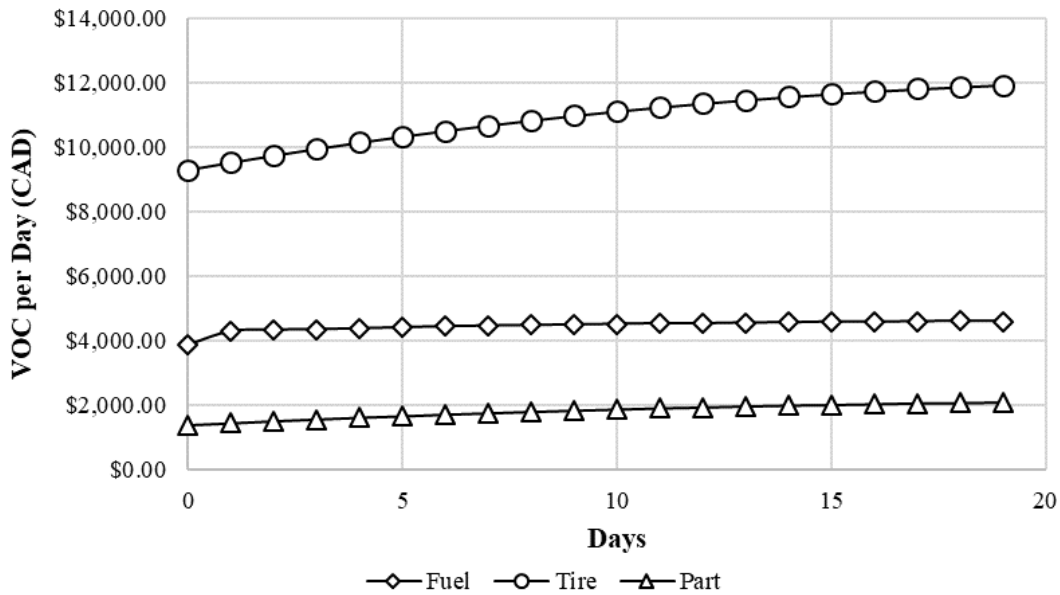
**Figure 50. VOC results based on the updated (better) transition matrix values**

Another set of values of the transition matrix are displayed in Table 15, which were assumed for an ideal design and construction condition. The corresponding *VOC* values are shown in Figure 51. If the haulage road designs are perfect, the simulation does not apply a maintenance service by

Maintenance node during the 20 work days. Therefore, the transition matrix values are important parameters to establish optimal *VOC* and the cost of maintenance. Based on the perfect level road condition' transition matrix, *VOC* is 343,642.26 CAD, which is less than *VOC* of the stochastic model.

**Table 15: Transition matrix values in excellent condition**

Surface condition	Excellent	Good	Medium	Poor	Very poor
Excellent	0.7	0.30	0	0	0
Good	0	0.75	0.25	0	0
Medium	0	0	0.80	0.20	0
Poor	0	0	0	0.85	0.15
Very poor	0	0	0	0	1



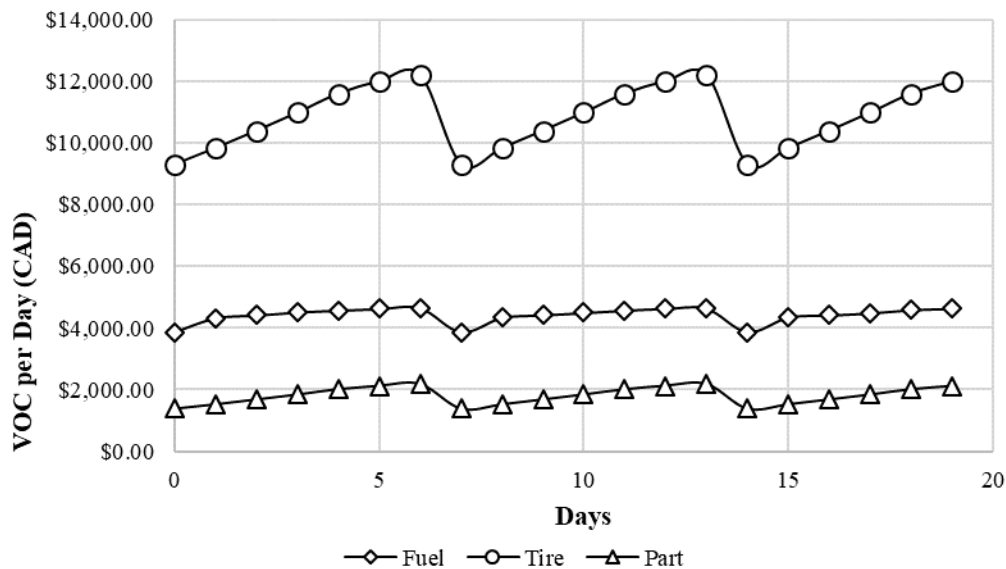
**Figure 51. VOC results based on the excellent condition values in transition matrix**

The last set of values were assumed for poor design and construction of haul road, which are displayed in Table 16. Given these transition values, new results for the *VOC* were calculated and

shown in Figure 52. In this condition, the simulation applies two maintenance services by Maintenance element during the 20 work days. While the road condition is poor, VOC is less than the case where the road condition is excellent, because maintenance service has the potential to decrease VOC. Based on the poor level of the transition matrix, VOC is 341,312.75 CAD.

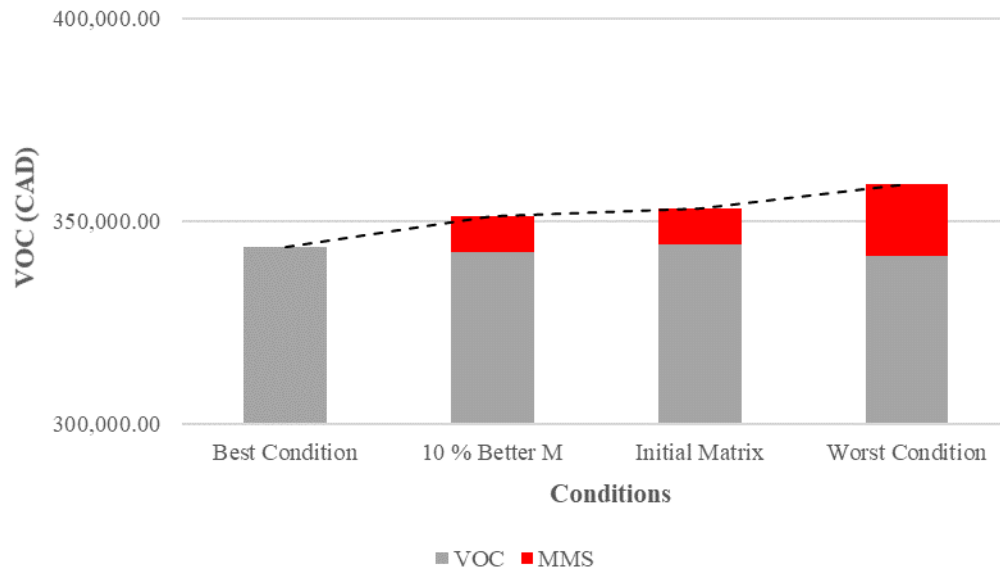
**Table 16: Transition matrix values in poor condition**

Surface condition	Excellent	Good	Medium	Poor	Very poor
Excellent	0.30	0.70	0	0	0
Good	0	0.25	0.75	0	0
Medium	0	0	0.20	0.80	0
Poor	0	0	0	0.15	0.85
Very poor	0	0	0	0	1



**Figure 52. VOC results based on the poor condition values in transition matrix**

However, the maintenance cost should be accounted in the estimations. Figure 53 shows total operating cost in the mentioned three scenarios, including VOC and maintenance costs and it, is represented in Table 24 in Appendix.



**Figure 53. VOC Analysis for Different Conditions in the Markov Model**

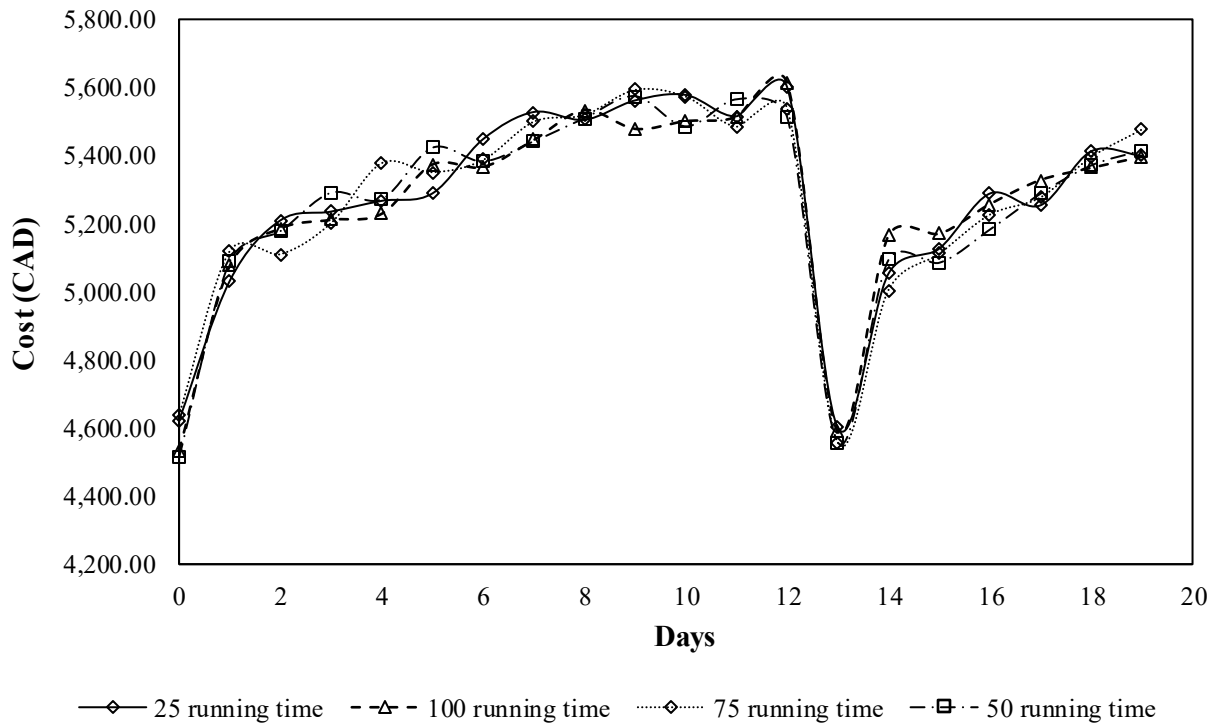
#### 4.4.1. Comparison of VOC Results based on Different Running Counts

Monte Carlo simulation was used for VOC and maintenance cost estimation in the earthmoving project (with their probabilities and impacts). A Monte Carlo simulation involves multiple simulations runs whereby in each run, the program randomly samples the from the provided distributions. The simulation is repeated multiple times until a set of sample results are calculated that could be used to represent the uncertainty associated with the project’s total cost estimate. This way, the stochastic and dynamic simulations will not produce the same output when they repeatedly run with independent random seeds. It requires one to make several runs with independent seeds for the random-number-generating streams to ensure that a real picture of the system under investigation is provided. Typically, a simulation collects sample output from the multiple runs conducted and then uses the sample as the basis for decision-making.

The choice of making 100 runs was arbitrary for the case study. In a real application, the

experimenter should derive the number of required runs based on the output parameter considered. In general terms, the larger the number of runs, the more accurate the results would be for two main reasons: (1) in a small number of runs, the properties of the system may not be completely revealed, and (2) the confidence intervals for the mean and variance of the results shrink as the number of runs increases. Formal statistical derivation can be followed to determine the number of runs required to predict a certain output parameter within some degree of confidence. Coverage of this, however, is not within the scope of this study. In practical terms, the number of runs should not be less than 10. AbuRizk and Hajjar (1982) suggested the use of 10 to 30 runs to predict the mean for steady-state simulation. This guideline is often adequate for inferring the underlying mean in a transient simulation as well.

During the study, the VOC element was examined under different running times. Simulation made 100 runs for 20 work days. Figure 54 shows different mean results of fuel consumption values based on a different number of runs. Based on the results, the maximum and minimum range values change in a different number of runs. For example, 14th-day fuel consumption was maximum at 100 runs (5,164 CAD), and the minimum fuel consumption was observed with 75 runs (5,005 CAD). These processes aim to incorporate variations, and randomness exists in the actual job sites, which helps to predict VOC realistically. Based on the prediction of VOC, maintenance management system or truck operations can be arranged for an optimum budget of the project.



**Figure 54. Different fuel consumptions based on the different running numbers**

## **Chapter 5: Conclusion**

This chapter discusses the main findings and contribution of the research projects. It also provides some directions for future research in this area.

### **5.1. Thesis Finding**

Selection of an efficient and optimum earthmoving haul road maintenance strategy is the key to realizing the economic benefits of reduced vehicle operating cost. Surface mine and heavy construction haul road maintenance systems, however, are generally managed using traditional approaches and are not tailored based on the complex interactions of wearing course functionality, road traffic volumes and vehicle operating and maintenance costs. By considering the change in haul road functionality over time, speed of the truck, the weight of truck and traffic volume, changes in rolling resistance, road deterioration, road maintenance costs and vehicle operating costs, an appropriate maintenance strategy should be developed to incorporate these elements. Thus, an optimized approach is required to minimize total road-user costs and a maintenance management modelling method for haul roads has been proposed to meet these needs.

Estimation of haulage rolling resistance, road deterioration, maintenance service frequency and vehicle operating cost can be carried out by deterministic, stochastic, and dynamic modelling methods. In the deterministic model, constants were used for the VOC calculation, and probabilistic values were employed in the stochastic and dynamic models which were developed in the Simphony.Net 4.6 environment. The simulation analysis methods were able to predict an optimal frequency of maintenance for unpaved haulage roads, which is not available in the literature.



A statistical relationship was shown between the models and VOC in different conditions. The results show that VOC estimations could be different based on the applied models. The truck speed, load, and transition matrix are critical parameters for rolling resistance that can be modelled, and proper strategies can be applied to control them for optimum total operating cost. The developed models provided an opportunity to investigate different scenarios for VOC and maintenance service frequency using deterministic, stochastic and dynamic modelling approaches.

Deterministic modelling results of the fuel consumption showed that the increase of the truckload and speed considerably increase fuel consumption. Based on the results, the speed is a more critical parameter than the load parameter on VOC, because it has a more destructive effect on the road surface. For example, if the truck speed is increased by 10 %, fuel consumption will increase by around 7 %. However, increasing the truckload by 10% will cause a 4% increase in fuel consumption in the stochastic model. Tire wearing cost values also depend on the surface condition of the haul road, where the larger roughness results in increased tire wear. The same trend exists with the parts consumption, but another important factor is the age of equipment, where the high RDS values have a larger negative impact on older trucks. For example, if the simulation uses a vehicle with 10 % lower operating hours, part consumption will decrease by 4 %.

The most important advantage of the dynamic modelling is that the road deterioration can be observed on site and the deterioration states can be modelled based on time. The transition matrix represents road deterioration as a dynamic parameter. Table 17 displays sample transition matrix values.

**Table 17. Sample transition matrix values**

Surface condition	Excellent	Good	Medium	Poor	Very poor
Excellent	0.5	0.5	0	0	0
Good	0	0.6	0.4	0	0

Medium	0	0	0.5	0.5	0
Poor	0	0	0	0.4	0.6
Very poor	0	0	0	0	1

An important benefit of the proposed models is to determine an optimal frequency of maintenance based on different scenarios for the end users. The users need to define different maintenance scenarios, either based on an RDS threshold and interval (days), then the model estimates VOC and maintenance costs in each scenario.

Results show that the tested simulation models in this study can be used to explain the relationship between vehicle operating cost and optimal maintenance frequency with probabilistic variables. Further, the values of calculated VOC are consistently less in the stochastic and deterministic models. Consequently, the concluded results show that this study appears to fit well with the published work of Thompson and Visser (2003), which represents the most comprehensive research in the haul road management field.

## 5.2. Limitation

The presented study is focused on the haulage efficiency with the lowest VOC in these three models. Simulation can operate under different conditions based on the updated variables. During the dynamic model, transition matrix values were assumed for the calculation. The main limitation of this approach is to collect Transition matrix values from the unpaved road surfaces in real-world cases. However, such a system was not investigated, and it needs some sensing technologies, such as unmanned aerial vehicles, onboard sensors, or terrestrial laser scanner. Thus, further research is needed to evaluate this method using the collected data from the job site.

### **5.3. Recommendations for Future Research**

Validation of the developed simulation systems should be carried out using a real test case. The transition matrix values are assumed during the study, but the system should be evaluated based on the obtained data from a test haulage road surface. Future research should consider estimating the transition matrix values using advanced sensing methods, namely image processing of the captured frames by areal platforms to detect a defect and therefore, estimate the RDS. Another potential approach is to use the sensor package on a smartphone while driving to collect and process synchronized data (e.g. GPS and accelerometer data) to detect defects of the road. Then the simulation could be run with the real data to estimate an optimum maintenance frequency.

## References

- AbouRizk, S. (2010). Role of simulation in construction engineering and management. *Journal of construction engineering and management*, 136(10), 1140-1153.
- AbouRizk, S. M., & Hajjar, D. (1998). A framework for applying simulation in construction. *Canadian journal of civil engineering*, 25(3), 604-617.
- Adedimila, A. S., Olutaiwo, A. O., & Kehinde, O. (2009). Models for a Developing Country. *J. Eng. Applied Sci*, 4(1), 13-26.
- Britton, M., Hodkiewicz, M., Kefford, A., McDonald, S., Chivers, G., & Lawson, G. (2012). Energy efficiency metrics in mine design.
- Caterpillar, (2006). CATERPILLAR PERFORMANCE HANDBOOK.
- Cenek, P. D., Henderson, R. J., & Davies, R. B. (2012). Selection of aggregates for skid resistance January 2012.
- CENEK, P., JAMIESON, N., & Ball, G. (1996). Effect of pavement deflection on rolling resistance of commercial vehicle tyres. In *Third International Symposium on Pavement Surface Characteristics*.
- Chatti, K., & Zaabar, I. (2012). *Estimating the effects of pavement condition on vehicle operating costs* (Vol. 720). Transportation Research Board.
- Clark, S. K. (Ed.). (1981). *Mechanics of pneumatic tires*. US Government Printing Office.
- Coffey, J., Nikraz, H., & Leek, C. (2018). Haul road rolling resistance and pavement condition. *Australian Journal of Civil Engineering*, 16(1), 12-22.
- Coffey, J., Nikraz, H., & Leek, C. (2019). Energy consumption in mine haulage due to road pavement performance. *Mining Technology*, 1-1”
- Dekker, R. (1996). Applications of maintenance optimization models: a review and analysis. *Reliability engineering & system safety*, 51(3), 229-240.
- Delcaro, U., Maulick, T., Pascali, L., & Turco, P. (2001). Friction potential and safety: Prediction of handling behavior. Guide lines for vehicle design. In *2nd International Colloquium on Vehicle Tyre Road Interaction, Florence, Italy*.
- Du Plessis, J. (1990). *Surface segregation*. Sci-Tech Publications.
- Evans, L. R., MacIsaac Jr, J. D., Harris, J. R., Yates, K., Dudek, W., Holmes, J., & Salaani, M. (2009). NHTSA tire fuel efficiency consumer information program development: phase 2—effects of tire rolling resistance levels on traction, treadwear, and vehicle fuel economy. *East Liberty, OH: National Highway Traffic Safety Administration*.
- Gao, H., & Zhang, X. (2013). A Markov-based road maintenance optimization model considering user costs. *Computer-Aided Civil and Infrastructure Engineering*, 28(6), 451-464.
- Goh, C. Y., Dauwels, J., Mitrovic, N., Asif, M. T., Oran, A., & Jaillet, P. (2012, September). Online map-matching based on hidden markov model for real-time traffic sensing

- applications. In *2012 15th International IEEE Conference on Intelligent Transportation Systems* (pp. 776-781). IEEE.
- Golabi, K., Kulkarni, R. B., & Way, G. B. (1982). A statewide pavement management system. *Interfaces*, 12(6), 5-21.
- Greenwood, I. R., & Bennett, C. R. (2003). TASK 2020-3 HDM-4 fuel consumption modelling. *Draft Report*.
- Hajjar, D., & AbouRizk, S. M. (2002). Unified modeling methodology for construction simulation. *Journal of Construction Engineering and Management*, 128(2), 174-185.
- Halpin, D. W., & Martinet, L. H. (1999). Real world applications of construction process simulation. In *WSC'99. 1999 Winter Simulation Conference Proceedings. 'Simulation-A Bridge to the Future'*(Cat. No. 99CH37038) (Vol. 2, pp. 956-962). IEEE.
- Hammarström, U., Eriksson, J., Karlsson, R., & Yahya, M. R. (2012). *Rolling resistance model, fuel consumption model and the traffic energy saving potential from changed road surface conditions*. Statens väg-och transportforskningsinstitut.
- Hillier, F. (2000). "Introduction to Operation Research." 6th edition. McGraw Hill, New York, USA.
- Hugo, D., Heyns, P. S., Thompson, R. J., & Visser, A. T. (2008). Haul road defect identification using measured truck response. *Journal of Terramechanics*, 45(3), 79-88.
- Jackson, R. L., Willis, J. R., Arnold, M., & Palmer, C. (2011). Synthesis of the effects of pavement properties on tire rolling resistance. *NCAT Report*, 11-05.
- Jameson, J. (2011). *Guide to pavement technology: part 5: pavement evaluation and treatment design* (No. AGPT05/11).
- Kaufman, W. W. (1977). *Design of surface mine haulage roads*.
- Kecojevic, V., & Komljenovic, D. (2010). Haul truck fuel consumption and CO<sub>2</sub> emission under various engine load conditions. *Mining engineering*, 62(12), 44-48.
- Lee, J., & Madanat, S. (2015). A joint bottom-up solution methodology for system-level pavement rehabilitation and reconstruction. *Transportation Research Part B: Methodological*, 78, 106-122.
- Lenngren, M., & Håkansson, C. (2010). CFD Analysis of Aerodynamic Trailer Devices for Drag Reduction.
- Li, Y., Liu, W. Y., & Frimpong, S. (2012). Effect of ambient temperature on stress, deformation and temperature of dump truck tire. *Engineering Failure Analysis*, 23, 55-62.
- Martinez, J. C., & Ioannou, P. G. (1999). General-purpose systems for effective construction simulation. *Journal of construction engineering and management*, 125(4), 265-276.
- McLean, J., & Foley, G. (1998). *Road surface characteristics and condition: effects on road users* (No. ARR 314).
- Moselhi, O., & Alshibani, A. (2009). Optimization of earthmoving operations in heavy civil engineering projects. *Journal of Construction Engineering and Management*, 135(10), 948-954."

- Nielsen, L., & Sandberg, T. (2002). A new model for rolling resistance of pneumatic tires. *SAE Transactions*, 1572-1579.
- Norgate, T., & Haque, N. (2010). Energy and greenhouse gas impacts of mining and mineral processing operations. *Journal of Cleaner Production*, 18(3), 266-274.
- Ortiz-García, J. J., Costello, S. B., & Snaith, M. S. (2006). Derivation of transition probability matrices for pavement deterioration modeling. *Journal of Transportation Engineering*, 132(2), 141-161.
- Plackett, C. W. (1985). A review of force prediction methods for off-road wheels. *Journal of agricultural engineering research*, 31(1), 1-29.
- Pye, K. (1995). The nature, origin and accumulation of loess. *Quaternary Science Reviews*, 14(7-8), 653-667.
- Sandberg, U. (2010). Pavements providing low rolling resistance. In *International Sustainable Pavements Workshop, Airlie Centre, Warrenton, VA, USA*.
- Sandberg, U., Bergiers, A., Ejsmont, J. A., Goubert, L., Karlsson, R., & Zöller, M. (2011). Road surface influence on tyre/road rolling resistance. *Swedish Road and Transport Research Institute (VTI), Linköping, Sweden, accessed Sept, 23, 2018*.
- Schmid, B., Ullidtz, P., & Jensen, B. (2009). Road pavements and fuel consumption. *Nordic Road and Transport Research*, (3).
- Schoenberg, M., & Sayers, C. M. (1995). Seismic anisotropy of fractured rock. *Geophysics*, 60(1), 204-211.
- Shastri, S. S. Kemper, S. F. Sonigra, T. R. Hill, T. R. Beales, J. (2012). Australia's mining thirst - GTL solution. Perth, Western Australia 6004.: GHD.
- Smilowitz, K., & Madanat, S. (2000). Optimal inspection and maintenance policies for infrastructure networks. *Computer-Aided Civil and Infrastructure Engineering*, 15(1), 5-13.
- Taborek, J. J. (1957). *Mechanics of vehicles*. Penton/Ipc Education Division.
- Tan, F., Thoresen, T., & Lloyd, B. (2011). *Update of vehicle/road relationships underpinning road user costs and externality costs: literature review* (No. AP-T189/11).
- Tannant, D, and Regensburg, B (2001). "Guidelines for Mine Haul Road Design." Vancouver : University of British Columbia Library
- Thompson, R. (2011). Mine haul road design and management: a review of current practice. *Transactions Society of Mining, Metallurgy and Exploration (SME)*, 328, 474-484.
- Thompson, R. J., & Visser, A. T. (1997). A mechanistic structural design procedure for surface mine haul roads. *International Journal of Surface Mining, Reclamation and Environment*, 11(3), 121-128.
- Thompson, R. J., & Visser, A. T. (2000). The functional design of surface mine haul roads. *Journal of the Southern African Institute of Mining and Metallurgy*, 100(3), 169-180.

- Thompson, R. J., & Visser, A. T. (2003). Mine haul road maintenance management systems. *Journal of the Southern African Institute of Mining and Metallurgy*, 103(5), 303-312.
- Thompson, R. J., & Visser, A. T. (2006). Selection and maintenance of mine haul road wearing course materials. *Mining Technology*, 115(4), 140-153.
- Thompson, R. J., & Visser, A. T. (2006). The impact of rolling resistance on fuel, speed and costs. *Continuous improvement case study*, 2(1), 68-75.
- Thompson, R. J., & Visser, A. T. (2007). Selection, performance and economic valuation of dust palliatives on surface mine haul roads. *Journal of the Southern African Institute of Mining and Metallurgy*, 107(7), 435-450.
- Torres-Machi, C., Chamorro, A., Yepes, V., & Pellicer, E. (2014). Current models and practices of economic and environmental evaluation for sustainable network-level pavement management. *Revista de la Construcción. Journal of Construction*, 13(2), 49-56.
- Vanegas, J. A., Bravo, E. B., & Halpin, D. W. (1993). Simulation technologies for planning heavy construction processes. *Journal of Construction Engineering and Management*, 119(2), 336-354.
- Widodo, N. P., Kramabibrata, S., Wicaksana, Y., Wattimena, R. K., & Hermawan, F. N. (2009). A Preliminary Field-study to Determine Rolling Resistance in Surface Coal Mines. In *International Symposium on Earth Science and Technology*.
- Woodman, C. A., & Cutler, A. T. (2002). Tyre selection, use and operational issues to maximise tyre life. *Otraco Int*, 1-18.
- Worm, J. M., & Van Harten, A. (1996). Model based decision support for planning of road maintenance. *Reliability Engineering & System Safety*, 51(3), 305-316.

## Appendix

**Table 18. RDS and RR values for VOC of Deterministic values.**

Days	RDS	RR
1	24.9481	0.181845
2	32.34263	0.26625
3	32.1104	0.265719
4	39.84377	0.282866
5	53.35527	0.310266
6	56.58584	0.316358
7	56.70774	0.316584
8	56.70902	0.316587
9	56.70903	0.316587
10	56.70903	0.316587

**Table 19. Total VOC for the Deterministic Model.**

Day	Fuel Consumption	Tire Cost	Part Cost
1	4988.439539	9307.0176	1370.4481
2	5604.591126	10016.8922	1557.8558
3	5594.478618	9994.59816	1551.9701
4	5710.725778	10737.0021	1747.9656
5	5923.269319	12034.106	2090.4025
6	5990.287295	12344.2405	2172.2783
7	5994.482077	12355.9429	2175.3678
8	5994.494809	12356.0664	2175.4004
9	5994.494851	12356.0668	2175.4005
10	5994.494851	12356.0668	2175.4005
11	5994.494851	12356.0668	2175.4005
12	5994.494851	12356.0668	2175.4005
13	5994.494851	12356.0668	2175.4005
14	5994.494851	12356.0668	2175.4005
15	5994.494851	12356.0668	2175.4005
16	5994.494851	12356.0668	2175.4005
17	5994.494851	12356.0668	2175.4005
18	5994.494851	12356.0668	2175.4005
19	5994.494851	12356.0668	2175.4005
20	5994.494851	12356.0668	2175.4005



**Table 20. Total VOC for the Deterministic Model based on the MMS.**

	Frequency of MMS (Day)			
	3	5	7	10
<b>VOC (CAD)</b>	332,762.99	352,919.05	367261.2919	381,680.49
<b>MMS Cost (CAD)</b>	53,448.00	35,632.00	17816	17816
<b>Total Cost (CAD)</b>	386,210.99	388,551.05	385,077.29	399,496.49

**Table 21. Total VOC for the Stochastic Model based on the Simulation Run.**

Day	MIN Fuel Consnp.	MAX Fuel Consnp.	Tire Cost	Part Cost
1	3847.785917	3886.820915	9306.672	1393.15659
2	4352.130501	4385.209382	10005.3167	1577.83645
3	4349.562452	4380.373592	9989.25743	1575.3595
4	4380.373592	4484.491866	10735.4083	1778.15327
5	4607.313925	4641.832242	11995.3752	2117.13673
6	4642.500093	4677.837537	12288.4691	2193.21215
7	4651.128386	4681.36458	12297.3072	2196.06331
8	4646.618177	4680.946545	12300.7072	2197.37188
9	4647.005226	4677.50219	12302.0991	2195.97643
10	4643.003268	4673.264348	12297.5921	2195.93067
11	4644.588608	4676.915285	12304.1697	2198.13276
12	4647.492595	4676.909594	12302.4343	2195.72426
13	4641.441846	4680.320791	12300.5472	2192.77375
14	4640.444972	4679.677756	12299.4625	2194.87227
15	4640.740639	4672.761893	12300.4402	2198.04205
16	4646.089634	4681.359804	12303.3394	2198.52185
17	4641.048088	4676.738585	12297.2864	2195.30976
18	4645.875811	4681.394915	12301.7705	2202.09668
19	4639.898626	4677.786669	12297.0644	2195.55254
20	4645.022378	4684.870681	12297.2772	2197.53479

**Table 22. Total VOC for the Stochastic Model based on the MMS.**

RDS	66.5	55	50	45	35
<b>VOC (CAD)</b>	369,452.00	328,684.59	317,087.00	317,173.36	309,200.05
<b>MMS Cost (CAD)</b>	0.00	26,724.00	35,632.00	35,632.00	53,448.00
<b>Total Cost (CAD)</b>	369,452.00	355,408.59	352,719.00	352,805.36	362,648.05

**Table 23. Total VOC for the Dynamic Model.**

<b>Day</b>	<b>Fuel Consp.</b>	<b>Tire Cost</b>	<b>Part Cost</b>
1	3,869.33	9,306.67	1,395.37
2	4,314.18	9,649.25	1,484.21
3	4,362.67	9,954.53	1,561.20
4	4,419.91	10,251.88	1,650.16
5	4,447.07	10,559.11	1,730.89
6	4,491.34	10,867.90	1,812.92
7	4,506.34	11,160.43	1,891.40
8	4,540.63	11,421.53	1,961.82
9	4,579.35	11,642.96	2,023.38
10	4,600.60	11,823.03	2,065.27
11	4,616.36	11,964.53	2,106.79
12	4,633.50	12,072.69	2,133.05
13	4,635.63	12,153.51	2,158.70
14	4,650.09	12,212.77	2,176.10
15	4,649.40	12,255.56	2,186.29
16	4,652.02	12,286.05	2,192.75
17	3,868.52	9,306.67	1,394.80
18	4,302.93	9,649.25	1,488.28
19	4,362.17	9,954.53	1,567.80
20	4,394.38	10,251.88	1,649.12

**Table 24. Total VOC for the Dynamic Model based on the MMS.**

<b>Road Condition</b>	<b>Best Condition</b>	<b>10 % Better M</b>	<b>Initial Matrix</b>	<b>Worst Condition</b>
<b>VOC (CAD)</b>	343,642.26	342,294.70	344,271.45	341,312.75
<b>MMS Cost (CAD)</b>	0.00	8,908.00	8,908.00	17,816.00
<b>Total Cost (CAD)</b>	343,642.26	351,202.70	353,179.45	359,128.75